

APOVAC AP 0110–0180 A

Sisteme de vid pentru industria chimic# #i cea farmaceutic#



Performan## verificat#

Sistem de vid standard cu pompe de vid cu inel de lichid DOLPHIN verificate, conceput special pentru procesele esen#iale din industria chimic# #i cea farmaceutic#, precum distilarea, cristalizarea, filtrarea, uscarea în vid

Robust

Manipularea gazelor toxice, corozive sau explozive, toleran## extrem de ridicat# la vapori #i particule, pentru condi#ii dificile ale proceselor, dubl# condensare pentru a asigura transferul minim #i recuperarea maxim# a solven#ilor

Rentabil

Costuri de operare reduse, durat# de func#ionare îndelungat#, între#inere minim#, durat# de via## extins#

APOVAC AP 0110–0180 A

Sisteme de vid pentru industria chimic# #i cea farmaceutic#



Desen dimensional

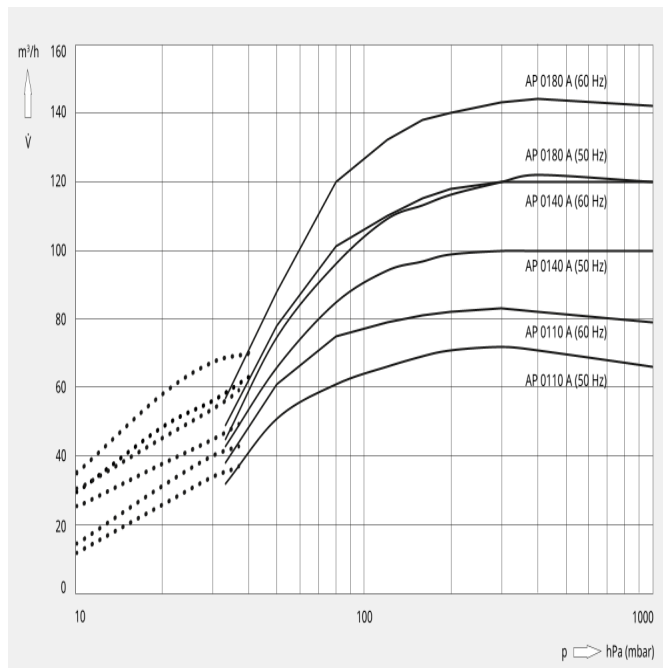
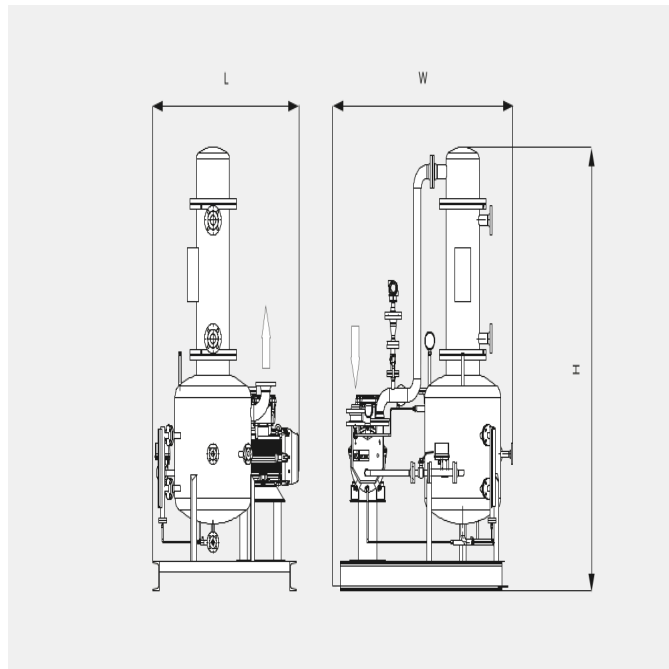

Urm#toarele valori tehnice se refer# la ISO 50 Hz

	AP 0110 A	AP 0140 A	AP 0180 A
Vitez# nominal# de pompare	72 m ³ /h	100 m ³ /h	122 m ³ /h
Presiune final#	33 hPa (mbar)	33 hPa (mbar)	33 hPa (mbar)
Putere nominal# a motorului	2,2 kW	3,0 kW	4,0 kW
Vitez# nominal# a motorului	1450 min ⁻¹	1450 min ⁻¹	1450 min ⁻¹
Greutate aprox.	600 kg	610 kg	620 kg
Dimensiuni (L x W x H)	1300 x 1300 x 1900 mm	1300 x 1300 x 1900 mm	1300 x 1300 x 1900 mm
Admisie gaz	DN 40	DN 40	DN 40
Evacuare gaz	DN 50	DN 50	DN 50

Urm#toarele valori tehnice se refer# la ISO 60 Hz

	AP 0110 A	AP 0140 A	AP 0180 A
Vitez# nominal# de pompare	83 m ³ /h	120 m ³ /h	144 m ³ /h

APOVAC AP 0110–0180 A

Sisteme de vid pentru industria chimic# #i cea farmaceutic#



	AP 0110 A	AP 0140 A	AP 0180 A
Presiune final#	10 (cu ejector op#ional) hPa (mbar)	10 (cu ejector op#ional) hPa (mbar)	10 (cu ejector op#ional) hPa (mbar)
Putere nominal# a motorului	3,0 kW	4,0 kW	5,5 kW
Vitez# nominal# a motorului	1750 min ⁻¹	1750 min ⁻¹	1750 min ⁻¹
Greutate aprox.	600 kg	610 kg	620 kg
Dimensiuni (L x W x H)	1300 x 1300 x 1900 mm	1300 x 1300 x 1900 mm	1300 x 1300 x 1900 mm
Admisie gaz	DN 40	DN 40	DN 40
Evacuare gaz	DN 50	DN 50	DN 50

DORI#I S# AFLA#I MAI MULTE

V# rug#m s# ne contacta#!
office@buschvacuum.ro sau +40 770 709 709



FORMULAR DE CONTACT



SUNA#I-NE ACUM