

Instruction Manual

VACTEST

Vacuum Measurement Equipment
Mobile Gauge TRP 900



Get technical data,
instruction manuals,
service kits



VACUUM APP

Table of Contents

1	Safety	3
2	Product Description	4
2.1	Interface Illustration	4
2.2	Product Identification	4
2.3	Delivery Content	4
2.4	Proper Use	5
2.5	Improper Use	5
3	Transport and Storage	5
4	Installation	5
4.1	Installation Conditions	5
4.2	Vacuum Connection.....	6
4.3	Electrical Connection	6
4.3.1	Battery Operation.....	7
4.3.2	Operation with External Power Supply	7
4.4	USB Interface	8
5	Operation	9
5.1	Select Operating Mode	9
5.2	Data Recording	9
5.3	Adjustment	11
5.4	Pressure Units	12
5.5	Maximum Operation Time	13
6	Communication	14
6.1	PC Mode.....	14
6.2	VacTest Explorer Software.....	14
7	Maintenance and Service	15
8	Troubleshooting	15
9	Accessories	15
10	Technical Data	16
11	EU Declaration of Conformity	17

1 Safety

- Read and follow the instructions of this manual.
- Inform yourself regarding hazards, which can be caused by the product or arise in your system.
- Comply with all safety instructions and regulations for accident prevention.
- Check regularly that all safety requirements are being complied with.
- Adhere to the applicable regulations and take the necessary precautions for the process media used.
- Consider possible reactions between materials and process media.
- Consider possible reactions of the process media due to the heat generated by the product.
- Before you start working, find out whether any of the vacuum components are contaminated.
- Adhere to the relevant regulations and take the necessary precautions when handling contaminated parts.
- Communicate the safety instructions to other users.

This instruction manual highlights potential hazards where appropriate. Safety notes and warning messages are tagged with one of the keywords DANGER, WARNING, CAUTION, NOTICE and NOTE as follows:

DANGER

... indicates an imminent dangerous situation that will result in death or serious injuries if not prevented.

WARNING

... indicates a potentially dangerous situation that could result in death or serious injuries.

CAUTION

... indicates a potentially dangerous situation that could result in minor injuries.

NOTICE

... indicates a potentially dangerous situation that could result in damage to property.

NOTE

... indicates helpful tips and recommendations, as well as information for efficient and trouble-free operation.

2 Product Description

The mobile gauge TRP 900 is equipped with a piezoresistive ceramic sensor and temperature compensated whose measurement principle is based on the change of resistance of a strain gauge resulting from a diaphragm deflection.

The piezoresistive sensor provides direct measurements which are independent of the gas nature.

The gauge can also be operated under vacuum inside of a vacuum chamber.

Due to the integrated data recorder functionality it is possible to store up to 2000 measurements in the vacuum gauge. By means of the USB interface you can transmit the stored measurement data to a PC or record measurements online on PC as well.

2.1 Interface Illustration

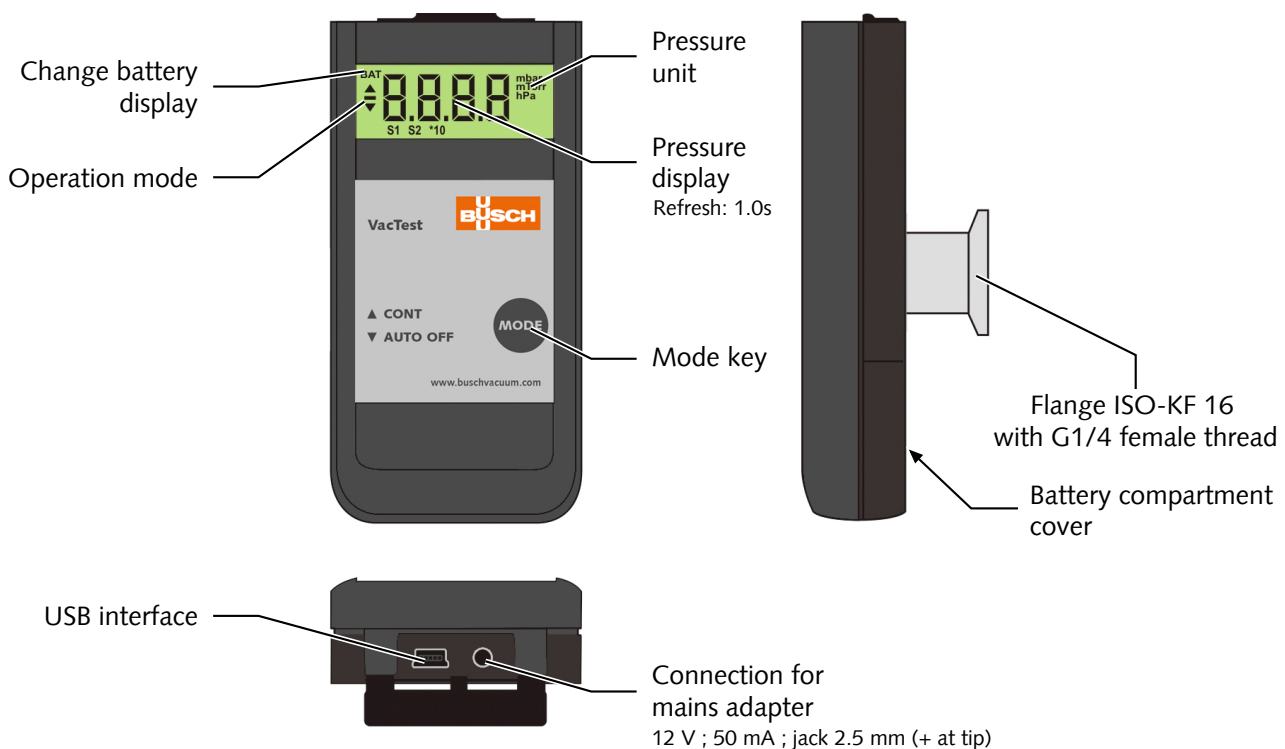

2.2 Product Identification

The product model can be found on the product's nameplate. Technical modifications are reserved without prior notification.

2.3 Delivery Content

Included in the delivery consignment are:

- Mobile gauge TRP 900
- Protective cover
- 9 Volt block battery
- Instruction manual

Available accessories, consult the chapter Accessories [► 15].

2.4 Proper Use

The TRP 900 serves exclusively to measure total pressure in a range of:

- 1600 ... 1 mbar.

2.5 Improper Use

The use for purposes not mentioned above is regarded as improper, especially:

- Connection to pumps or units which are not suitable for this purpose according to their operating instructions.
- Connection to units which have exposed voltage-carrying parts.
- Operation of the devices in areas with ionizing radiation.

No liability or warranty will be accepted for claims arising from improper use.

3 Transport and Storage

- Check the device for transport damage.

NOTICE

Devices without external protection.

Risk of damage to the device!

- The device must not come into contact with electrostatically chargeable materials and must not be moved within electrical or high magnetic fields.

If a storage is planned:

- Seal the vacuum flange with the protective cover.
- Comply with the storage temperatures, see technical data.
- In rooms with moist or aggressive atmospheres, the device must be airproof shrink-wrapped in a plastic bag together with a bag a desiccant.

4 Installation

CAUTION

Unauthorized modifications.

Risk to injury!

- Modifications or conversions of the gauge are not allowed.

4.1 Installation Conditions

- Make sure that the environment of the device is not potentially explosive.
- Make sure that the ambient conditions comply with the Technical Data [► 16].

4.2 Vacuum Connection

CAUTION

Unintended opening of clamp with an overpressure in the vacuum system over 1000 mbar.

Risk to injury!

Damage to your health!

- Parts may fly around.
- Unsecured hose connections can release process media.

CAUTION

Overpressure in the vacuum system over 1500 mbar

Damage to your health!

The elastomer washers cannot withstand the pressure and can release process media.

- Use sealing rings with an outer centering ring.

NOTICE

Dirt and damage at the vacuum flange.

Impair the function of the gauge!

- Make sure that the flange is clean, dry and free of grease.
 - When handling the instrument, make sure that the flange is protected against dirt and damage.
-
- Remove the protective cover (is required again during maintenance work!).
 - Connect the flange to the system.

Connection size:

- ISO KF 16
- G1/4 (female)

- Make sure that the sensor flange is connected to the ground, when operated with external power supply.

4.3 Electrical Connection

4.3.1 Battery Operation

Before operating the gauge a suitable battery or rechargeable battery must be inserted.

- Pull the battery cover on the back of the unit downwards and insert the battery
- Close the cover again by pushing it upwards until it snaps into position.

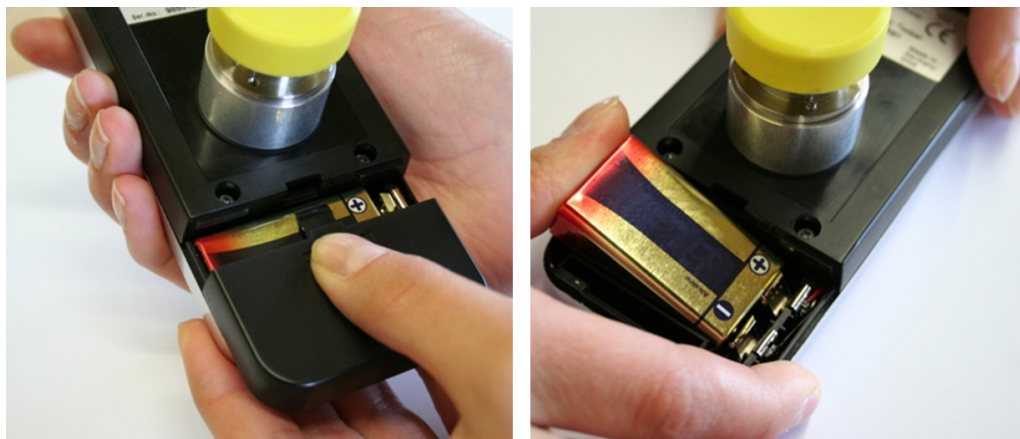

Battery types:

- 9 Volt AlMn block battery type 6LR 61; lifetime max. 2500 hours
- 9 Volt Lithium block battery; lifetime max. 5000 hours.
- 9 Volt NiCd rechargeable battery 150 mA; lifetime max 500 hours.

NOTICE

Inferior or damaged batteries may leak gas or liquid under vacuum.

Risk of damage to the gauge!

- If it is intended to expose the entire gauge to vacuum, seek confirmation from the battery supplier that the battery is vacuum proof.

NOTE

Poor battery power is indicated by the "BAT"-prompt in the upper left corner of the display. Operation of the gauge is still possible. Once the battery is completely discharged, the gauge switches off.

Rechargeable batteries have to be removed for charging. Please use suitable, commercially available chargers.

4.3.2 Operation with External Power Supply

The gauge can be operated alternatively with an external 12V power supply. The socket for the power supply is located behind the dust protection lid.

- Open the lid carefully and pull it out slightly.

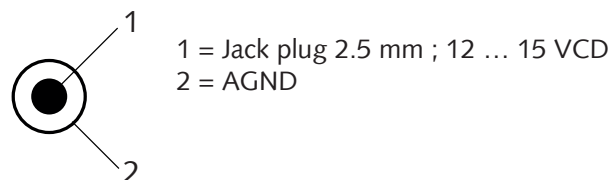

i NOTE

The battery can be left in the gauge when the external power supply is used. A rechargeable battery will not be loaded but can remain in the gauge.

4.4 USB Interface

The USB port can be connected to a PC via VacTest explorer to read out stored measurement data, transmit measurement values or configure the gauge.

Connector type: Mini USB Type B

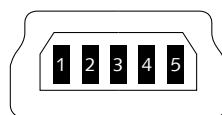

1 = VCC ; +5 V
2 = Data -
3 = Data +
4 = GND
5 = GND

5 Operation

5.1 Select Operating Mode

Short-Term Operation "Auto-Off" mode

- Press "Mode" key

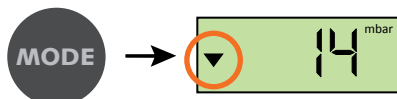

The current pressure is displayed.

The gauge will automatically shut down after 20 seconds.

Continuous Operation "Cont" mode

Notes: Available only when data recorder function is disabled.

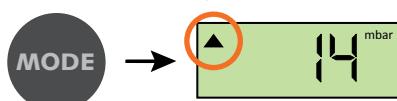

The current pressure is displayed.

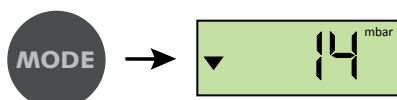

If the "Cont" mode is activated, the gauge is in continuous operation until it is switched off manually or, after the maximum operation time is reached.

5.2 Data Recording

To operate the gauge as a pressure display with data recorder functionality, activate the recording function as described below.

Activate the data recording and configure the storage interval

In order to configure the storage interval, the gauge's configuration mode must be activated.

Starting condition: the gauge is switched off.

- Hold "Mode" key pressed for approx. 5 seconds, until the display shows "rAtE".

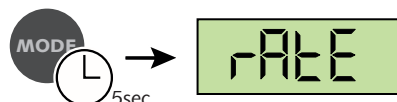

After additional 5s the current rate setting for internal data recording is displayed and can now be adjusted by means of the "Mode" key.



"off" : data recording is disabled.

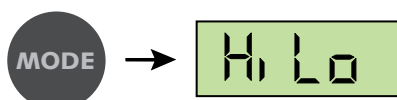

"HiLo" means that only minimum and maximum pressures are stored.

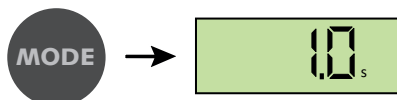

Save measurements every 1 s.
Other storage intervals: 2 s, 10 s, 1 min, 10 min

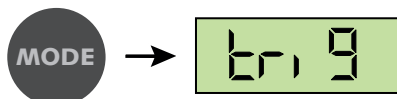

"trig" means that new measurement values will only be recorded if the current value differs from the last stored value by at least 2 digits (e.g. 2.3 ... 2.5). This reduces the data volume and optimally uses the storage capacity of the gauge.

When data recording is active, minimum and maximum pressure are recorded simultaneously.

Without further keystroke the gauge is switched into "Auto-Off" mode after 5 seconds. The last settings are saved.

i NOTE

Via USB interface the user can set recording rates between 1.0 s and 6000 s. The recording rate will stay available in the menu after "trig".

Stored Maximum Pressure

- Press "Mode" key until "Hi" is displayed.

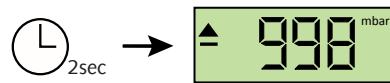
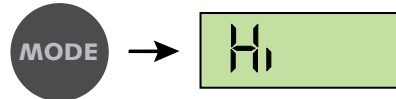

After two seconds the stored maximum pressure is displayed

Without further keystroke the gauge is switched into "Auto-Off" mode after 5 seconds.

Stored Minimum Pressure

- Press "Mode" key until "Lo" is displayed

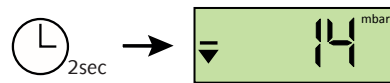
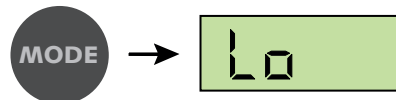

After two seconds the stored minimum pressure is displayed

Without further keystroke the gauge is switched into "Auto-Off" mode after 5 seconds.

Delete Memory

- Press "Mode" key until "cLr" is displayed

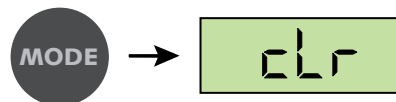

On further keystroke the stored Min-/Max-values as well as the data memory are deleted.

Without further keystroke the gauge is switched into "Auto-Off" mode after 5 seconds.

Data Recording

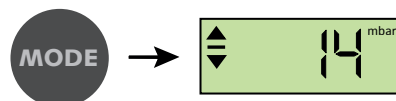

The current pressure is displayed. Measurement values are stored according to the configured storage interval.

The recording mode stops as soon as the gauge is full (max. of 2000 measurement values) or if the is shut down.

Quit Data Recording Mode

- Double keystroke: device switches into auto-off mode and will shut down automatically after approximately 10 seconds.

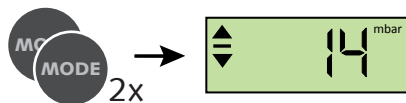

5.3 Adjustment

The gauge is factory calibrated in upright position. Other orientations, different climatic conditions, extreme temperature changes, ageing or contamination may necessitate re-adjustment.

NOTE

Conduct adjustment at the same ambient temperature at which the device is typically operated.

- Activate the configuration mode to perform the adjustment.

Starting condition: the gauge is switched off.

- Hold the "Mode" key pressed for approx. 5 seconds, until the display shows "rAtE".

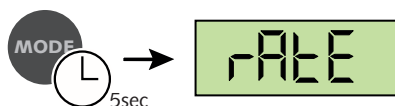

- Press the "Mode" key repeatedly until "CAL" is displayed.

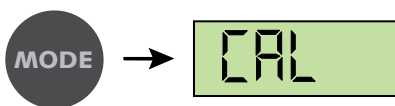

Adjustment to Atmosphere Pressure

NOTE

Adjustment on atmosphere pressure is possible only if the current pressure is above 800 mbar. Otherwise adjustment is denied and the error message "Err" displayed.



- Confirm CAL.H by pressing the "Mode" key.

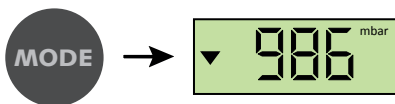

- Press the "Mode" key to adjust the reference value.

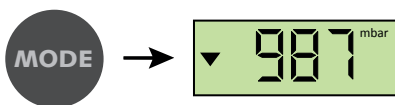

After 5s without further keystroke adjustment is performed.



Without further keystroke, the unit switches to "Auto-Off" mode after approx. 5 seconds.

Adjustment to Zero Pressure

 **NOTE**

For adjustment on zero pressure the current pressure inside the sensor has to be less than 0.1 mbar.

The pressure reading must be less than 100 mbar, otherwise adjustment is denied and the error message "Err" displayed.

- Activate the configuration mode to perform the adjustment.

Starting condition: the gauge is switched off.

- Hold the "Mode" key pressed for approx. 5 seconds, until the display shows "rAtE".

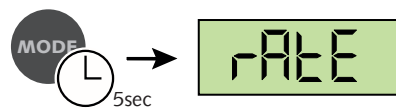

After 5 more seconds the display shows:



- Press "Mode" key to adjust the reference value.

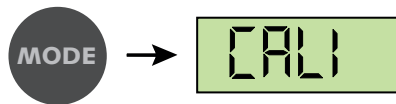

During the adjustment procedure (approx. 20s) the display shows "CALI"

Without further keystroke, the unit switches to "Auto-Off" mode after approx. 5 seconds.

Calibration messages



If during the calibration, the message "Ur" appears, it means that the adjustment has been successfully achieved.



If during the calibration, the message "Err" appears, it means that no adjustment was performed.

5.4 Pressure Units

In order to change the pressure units, the gauge's configuration mode must be activated. Starting condition: the gauge is switched off.

- Hold the "Mode" key pressed for approx. 5 seconds, until the display shows "rAtE".

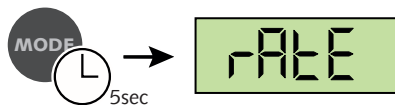

- Press "Mode" key repeatedly until "unit" is displayed.

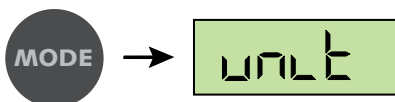

After 5 seconds the current unit setting is displayed:

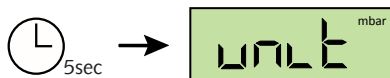

- Within 10 s, select "mbar", "Torr" or "hPa" using the mode key

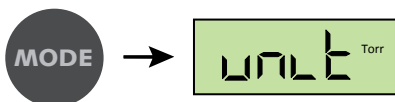

Without further keystroke, the unit switches to "Auto-Off" mode after approx. 5 seconds. The last settings are saved.

5.5 Maximum Operation Time

When operating continuously in "Cont" mode or "Data Recording" mode the unit stays on, until the selected maximum operation time has elapsed.

In order to change this time, the gauge's configuration mode must be activated. Starting condition: the gauge is switched off.

- Hold the "Mode" key pressed for approx. 5 seconds, until the display shows "rAtE".

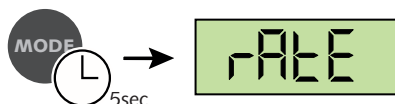

- Press "Mode" key repeatedly until "hour" is displayed.

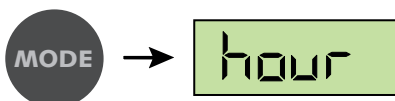

After 5 seconds the current setting of maximum operation time is displayed:



- Select a timespan from 1h to 24h or "cont" (no switch-off) with the "Mode" key.

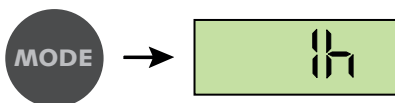

Without further keystroke, the unit switches to "Auto-Off" mode after approx. 5 seconds. The last settings are saved.

6 Communication

NOTE

The Busch communication protocol is available separately on request.

Ask your Busch representative to get the document.

6.1 PC Mode

The gauge can be connected to a PC via a USB interface in order to transmit the measurement data. The VacTest explorer software supports recording current pressure values (online measurement) as well as reading out the measurement values stored within the gauge.

The measurement data are plotted as a diagram and can be exported as a text file for further analysis.

Further you can perform any parameter settings such as recording rate, display unit or gas correction factor easily by means of the VacTest explorer.

The gauge is switched into PC Mode as soon as a cable connection with a free PC USB port is established:



The gauge is now ready for bidirectional data transmission. The communication is performed according to the Busch communication protocol.

NOTE

When the gauge is switched into PC Mode, actual pressure display as well as any data recording that may be running will be stopped.

After the USB cable is disconnected the gauge switches into "Auto-Off" mode.

6.2 VacTest Explorer Software

VacTest explorer software has been especially developed for use with Busch vacuum gauges and is available for Windows and Android operating systems.

VacTest explorer features plotting and saving of measurement data as well as a comfortable way of configuring all device parameters.

Download VacTest explorer software on the Busch website www.buschvacuum.com.

Features example:

- Plot, analyze and save measurement curves.
- Compare multiple plots.
- Export measurement data for MS Excel.
- Automatic calculation of leak rates by rate-of-rise measurements.
- Easy configuration of all device parameters.
- Scaling wizard with graphic support for adjusting the voltage output characteristic.
- The voltage output curve can be modified through the VacTest explorer software and can directly replace gauges of other brands.

7 Maintenance and Service



WARNING

Units contaminated with hazardous material.

Risk of poisoning!

Risk of infection!

If the unit is contaminated with hazardous material:

- Wear appropriate personal protective equipment.

The device requires no maintenance. External dirt and soiling can be removed by a damp cloth.

Should a defect or damage occur on the device, please send the unit to us for repair and fulfil the declaration of decontamination downloadable from www.buschvacuum.com.

NOTE

Malfunction of the unit, which is caused by contamination or wear and tear is not covered by warranty.

8 Troubleshooting

Problem	Possible Cause	Remedy
High measurement error.	Contamination, ageing, extreme temperature, maladjustment.	• Readjustment, replace sensor or send unit for repair.
Display shows " or ".	Pressure over-range.	• Pressure > 1600 mbar.
Error message "Err".	adjustment done at wrong pressure.	• Displayed pressure must be >800 mbar f. atmosphere adjustment, <100 mbar f. zero adjustment.
	measurement error out of adjustment range.	• Send unit for repair.
Error message "Err1".	Defective sensor.	• Send unit for repair.

9 Accessories

Accessory	Description	Part no.
Accessory set	- Alkaline block battery 9 V - Protective case - Power supply 100 - 240 VAC, AC with EURO/US/UK/AUS plugs - Software: VacTest explorer - Pro version - USB interface cable for PC – 2 meters	0947 204 607
Hose nozzle adapter	LW6-8 - G1/4 male	0574 204 602
Connecting cable	USB interface cable for PC – 2 meters	0671 204 565
Software	VacTest explorer - Pro version (1 license)	0870 203 191

This is only part of the available accessories, check on Busch's website or contact your Busch representative for more information.

10 Technical Data

		VacTest TRP 900
Measurement principle		Piezoresistive
Materials exposed to vacuum		Stainless steel 1.4305, Al ₂ O ₃ ceramic, FKM
Measuring range	mbar	1600 ... 1
	torr	1200 ... 0.75
Overpressure limit	bar abs.	4
Measurement uncertainty	% full scale	±0.3 % (linearity, hysteresis, repeatability)
Resolution		1 mbar
Reaction time	s	<1
Measuring rate	s	0.05 ... 6000
Serial Interface		USB
Electrical Connection		2.5 mm mini-Jack for external power supply
Supply voltage		9 V block battery or 15 VDC external
Max. battery operating time	h	2500
Power consumption	mW	2
Operating temperature	°C	0 ... +50
Storage temperature	°C	-20 ... +60
Relative Humidity:		max. 85%, not condensing
Ambient pressure:	hPa (mbar)	860 ... 1060
Protection Class		IP 40
Weight	g	200

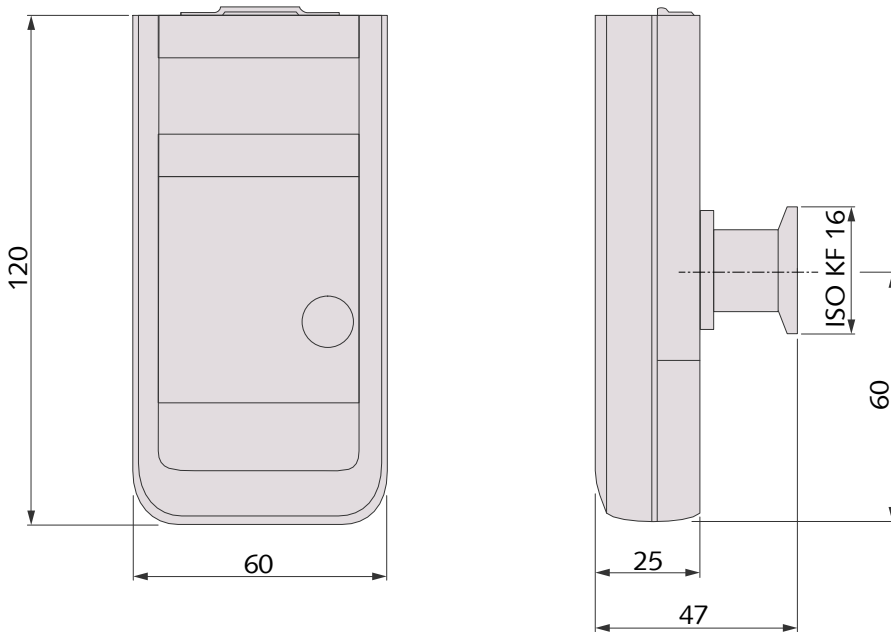

11 EU Declaration of Conformity

This Declaration of Conformity and the CE-mark affixed to the nameplate are valid for the gauge within the Busch scope of delivery. This Declaration of Conformity is issued under the sole responsibility of the manufacturer.

The manufacturer

Busch Produktions GmbH
Schauinslandstr. 1
DE-79689 Maulburg

declare that the gauge VacTest TRP 900

has been manufactured in accordance with the European Directives:

- 'Electromagnetic Compatibility (EMS) ' 2014/30/EU
- 'RoHS' 2011/65/EU, restriction of the use of certain hazardous substances in electrical and electronic equipment

and following the standards.

Standard	Title of the Standard
EN 61326-1:2013 Group 1 / Class B	Electrical equipment for measurement, control and laboratory use. EMC requirements. General requirements
EN 50581:2012	Technical documentation for the assessment of electrical and electronic products with respect to the restriction of hazardous substances

Person authorised to compile the technical file:

Gerd Rohweder
 Busch Dienste GmbH
 Schauinslandstr. 1
 DE-79689 Maulburg

Maulburg, 24.08.2017



Martin Gutmann, General director

Note

A large, empty rectangular box with a thin grey border, occupying most of the page below the 'Note' header. It is intended for the user to write their notes.



Busch

Vacuum Solutions

We shape vacuum for you.

Argentina

info@busch.com.ar

Australia

sales@busch.com.au

Austria

busch@busch.at

Bangladesh

sales@busch.com.bd

Belgium

info@busch.be

Brazil

vendas@buschdobrasil.com.br

Canada

info@busch.ca

Chile

info@busch.cl

China

info@busch-china.com

Colombia

info@buschvacuum.co

Czech Republic

info@buschvacuum.cz

Denmark

info@busch.dk

Finland

info@busch.fi

France

busch@busch.fr

Germany

info@busch.de

Hungary

busch@buschvacuum.hu

India

sales@buschindia.com

Ireland

sales@busch.ie

Israel

service_sales@busch.co.il

Italy

info@busch.it

Japan

info@busch.co.jp

Korea

busch@busch.co.kr

Malaysia

busch@busch.com.my

Mexico

info@busch.com.mx

Netherlands

info@busch.nl

New Zealand

sales@busch.co.nz

Norway

post@busch.no

Peru

info@busch.com.pe

Poland

busch@busch.com.pl

Portugal

busch@busch.pt

Romania

office@buschromania.ro

Russia

info@busch.ru

Singapore

sales@busch.com.sg

South Africa

info@busch.co.za

Spain

contacto@buschiberica.es

Sweden

info@busch.se

Switzerland

info@buschag.ch

Taiwan

service@busch.com.tw

Thailand

info@busch.co.th

Turkey

vakutek@ttmail.com

United Arab Emirates

sales@busch.ae

United Kingdom

sales@busch.co.uk

USA

info@buschusa.com