

PUMA WY 3600 A

Vacuum booster

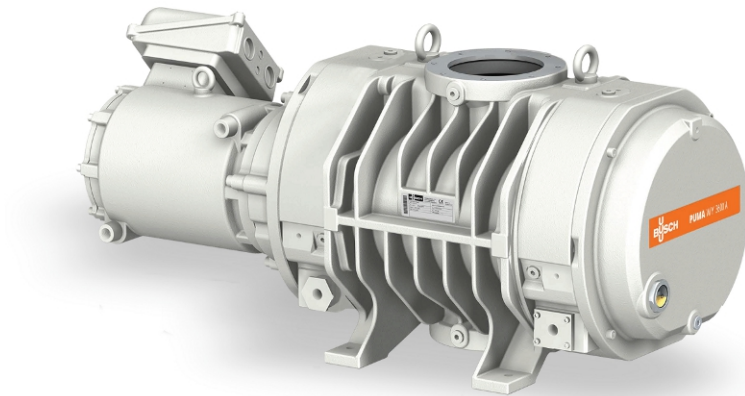

VACUUM SOLUTIONS



Reliable

Special lobe design to prevent powder and particle deposits, robust construction made of GGG40 material, leak-tight

High performance

Specially designed for harsh applications in the medium and high vacuum range, including semiconductor processes with powder and dust, excellent volumetric efficiency

Flexible

Reliable performance under varying operating conditions, boosts the performance of all types of backing pumps

PUMA WY 3600 A

Vacuum booster



VACUUM SOLUTIONS

Dimensional drawing

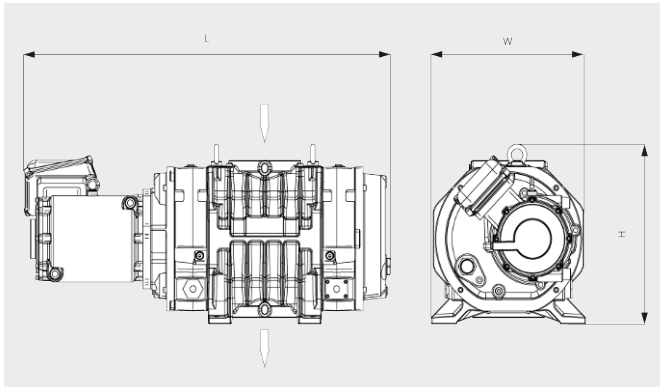

Pumping speed

Air at 20°C. Tolerance: ± 10%

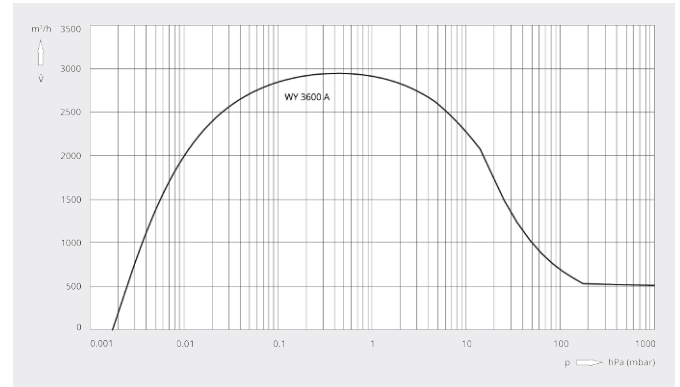

PUMA WY 3600 A	
Nominal pumping speed	3600 m³/h
Pumping speed	2945 m³/h *
Max. differential pressure	30 hPa (mbar)
Nominal motor rating	15 kW
Nominal motor speed	5400 min ⁻¹
Weight approx.	500 kg
Leakage rate	< 1 · 10 ⁻⁶ mbar · l/s
Dimensions (L x W x H)	1139 x 524 x 480 mm
Gas inlet / outlet	DN 160 ISO / DN 160 ISO

*Pumping speed with COBRA NS 0600 C as backing pump running at 50 / 60 Hz
Frequency converter is necessary

DO YOU WANT TO KNOW MORE?

Get in touch with us directly!
busch@busch.com.my or +60 (0)3 55 25 95 00



CONTACT FORM



CALL NOW