

Instruction manual

SECO

Dry-Running Rotary Vane Vacuum Pumps and Compressors
SV/SD 1100 C



Table of Contents

Introduction	2
Product description	3
Use	3
Principle of operation	3
Versions	4
Cooling	4
Operational Options/ Use of Optionally Available Equipment	4
On/ Off switch	4
Safety	4
Intended use	4
Safety notes	4
Sound Emissions	4
Transport	4
Storage	4
Short-term Storage	4
Installation and Commissioning	5
Installation prerequisites	5
Installation Position and Space	5
Suction Connection	5
Discharge connection	5
Electrical Connection / Controls	5
Installation	6
Mounting	6
Electrical connection	6
SV/SD 1100 C	6
Notes on Operation	7
Application	7
Maintenance	7
Maintenance Schedule	8
Every 6 Months:	8
Every 100 - 500 Operating hours	8
Every 1000 Operating hours	8
Every 1000 - 2000 Operating hours	8
Inlet filter and pressure filter (SD)	8
Vanes	8
Overhaul	8
Removal from Service	8
Temporary Removal from Service	8
Recommissioning	8
Dismantling and Disposal	9
Troubleshooting	10
Exploded view	13
Spare parts	14
Gasket kit	14
Full service kit	14
Accessories	15
Technical data	16
EU Declaration of Conformity	17
UK Declaration of Conformity	18

Introduction

Congratulations on your purchase of this Busch vacuum pump. Through careful observation of the field's requirements, innovation and continuous development, Busch delivers modern vacuum and pressure solutions worldwide.

These operating instructions contain information on

- product description,
- safety,
- transport,
- storage,
- installation and commissioning
- maintenance,
- overhaul,
- troubleshooting

of the vacuum pump.

For the purpose of these instructions, "handling" the vacuum system means the transport, storage, installation, commissioning, influence on operating conditions, maintenance, troubleshooting and overhaul of the vacuum system.

Prior to handling the vacuum system, these operating instructions must be read and understood. If anything remains to be clarified, please contact your Busch representative!

Keep these operating instructions and, if applicable, any other relevant operating instructions available and accessible on site.

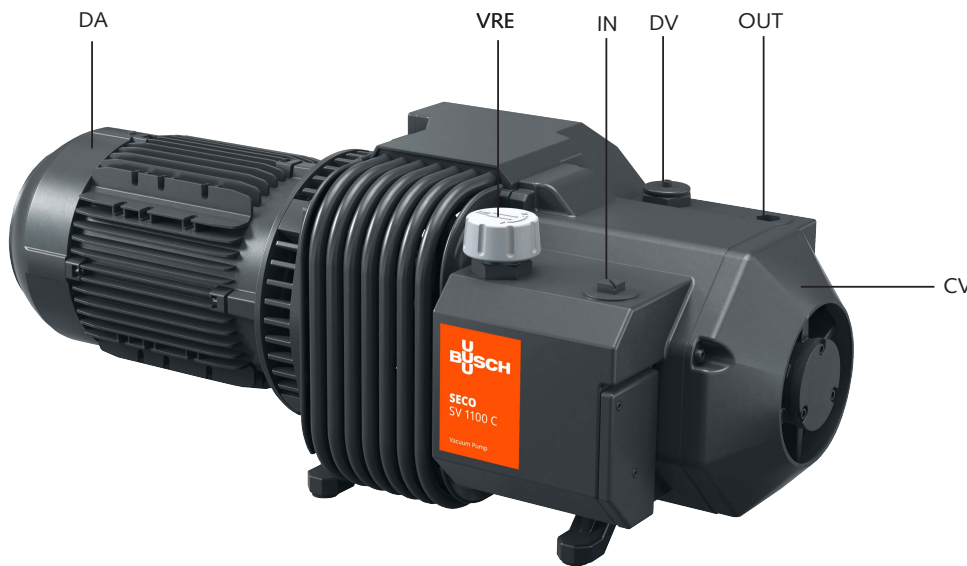

- IN Suction connection
- OUT Gas discharge
- VRE Vacuum relief valve (SV series only)
- DV Discharge silencer valve (SV series only)
- CV Cover
- DA Arrow label
- IF Inlet filter
- VA Vanes
- RT Rotor
- IDF Pressure filter
- PRV Pressure relief valve (SD uniquement)

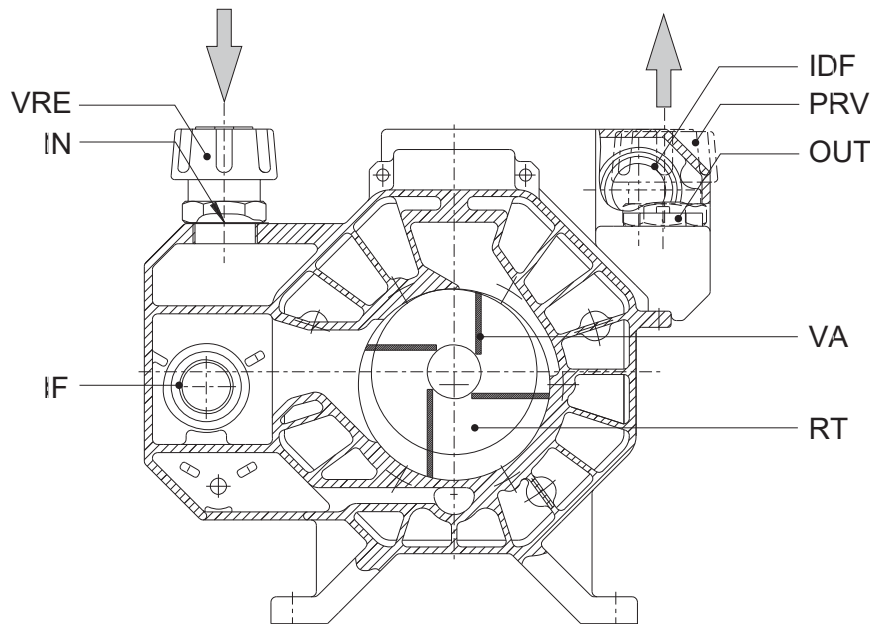

Product description

Use

This vacuum pump is intended for

- the suction (SV) or the discharge (SD)

of

- air and other dry, non-aggressive, non-toxic and non-explosive gases.

Conveying media with a higher density than air leads to an increased thermal and mechanical load on the vacuum pump and is permissible only after prior consultation with Busch.

The vacuum pump is intended for placement in a potentially non-explosive environment.

Max. permissible number of starts per hour: 12.

The vacuum pump is thermally suitable for continuous operation.

The vacuum pump is ultimate pressure proof.



CAUTION

This vacuum pump is a dry running pump.

Do not lubricate the vacuum pump with oil or grease.

Principle of operation

The vacuum pump works according to the rotating vane principle.

A eccentric rotor (RT) rotates in the cylinder. The centrifugal force of the rotation pushes the vanes (VA), which are sliding in slots in the rotor, to-wards the wall of the cylinder. The vanes separate the sickle-shaped space between rotor and cylinder into different chambers. When the chambers are connected with the inlet channel, gas is drawn in, com-pressed by the next rotation and then discharged.

The compression is done without the use of any kind of external lubricant for lubrication. The drawn gases go through an integrated fine mesh inlet filter (IF).

The efficient fan enables successful removal of heat from the motor and the pump cover.

Versions

Two versions of the SECO rotary vane vacuum pumps are available :

- ◆ **Model SV**
For vacuum applications down to an ultimate pressure of 100 hPa.
- ◆ **Model SD**
For overpressure duties up to 1500 hPa (2500 hPa abs.).

Cooling

The vacuum pump is cooled by

- the ambient air around the vacuum pump
- the air flow from the drive motor fan
- an air cooling coil

Operational Options/ Use of Optionally Available Equipment

- Air filter to be fitted in series to the integral inlet filter when air with a higher content of dust is being drawn.
- Vacuum relief valve to control inlet pressure when pump is used on vacuum duties (SV series only).
- Pressure relief valve to control pressure when pump is used on overpressure duties (SD series only).
- A non-return valve, fitted to either the suction or the discharge line, protects the system against ingress of air or depressurization, should the pump stop for any reason. The installation of non-return valves is recommended if lines of more than 5 meters are used.

On/ Off switch

This vacuum pump comes without an on/off switch. The control of the vacuum pump has to be provided for in the course of installation.

Safety

Intended use

DEFINITION: For the purpose of these instructions, “handling” the vacuum pump means the transport, storage, installation, commissioning, influence on operating conditions, maintenance, troubleshooting and overhaul of the vacuum pump.

The vacuum pump is intended for industrial use. It should only be handled by qualified personnel.

The different application of the pump and operational limits according to the “Product Description” and the “Installation Prerequisites” of the vacuum pump must be observed both by the manufacturer of the machinery into which the vacuum pump is to be incorporated, and by the operator.

The maintenance instructions must be adhered to.

Prior to handling the vacuum pump, these operating instructions must be read and understood. If anything remains to be clarified, please contact your Busch representative!

Safety notes

This vacuum pump has been designed and manufactured in accordance with the latest technical standards, and with current safety requirements. Nevertheless, residual risks may remain. These operating instructions inform about potential hazards where appropriate. Safety notes are tagged with one of the keywords DANGER, WARNING and CAUTION as follows:



DANGER

Disregard of this safety note will always lead to accidents with fatal or serious injuries.



WARNING

Disregard of this safety note may lead to accidents with fatal or serious injuries.



CAUTION

Disregard of this safety note may lead to accidents with minor injuries or property damage.

Sound Emissions

For the sound pressure level in free field operation according to EN ISO 2151, please see “Technical Data”.



CAUTION

The vacuum pump emits noise of medium intensity.

Risk of damage to hearing.

People staying in the vicinity of a non-noise insulated vacuum pump over extended periods of time must wear suitable ear protection.

Transport



CAUTION

Please check the weight of the vacuum pump before lifting it up (see “Technical Data”)

Use adequate lifting gear for this.

Seco vacuum pumps pass a rigorous operating test in the factory and are packed carefully to avoid transit damage.

The suction and the discharge apertures are sealed with plugs so that no dirt can enter the pump during transport. These protections must be removed before connecting the vacuum pump. Please check packaging on delivery for any transport damage.

The pump can be lifted from its packaging with a suitable lifting device using the lifting bracket on the pump.

Packing materials should be disposed of according to environmental laws, or reused.



CAUTION

Do not walk, work or stand under suspended loads.

Storage

Short-term Storage

- Make sure that the suction connection/gas inlet and the gas discharge/pressure connection are closed (refit the plugs the pump was delivered with)
- Store the vacuum pump
 - if possible in its original packaging,
 - indoors,
 - dry,
 - dust free
 - vibration free

Installation and Commissioning

Installation prerequisites



CAUTION

In case of non-compliance with the installation prerequisites, particularly in case of insufficient cooling:

Risk of damage or destruction of the vacuum pump and adjoining plant components!

Risk of injury!

The installation prerequisites must be complied with.

- Make sure that the integration of the vacuum pump is carried out in such a way that the essential safety requirements of the Machine Directive 2006/42/EC are complied with (it is the responsibility of the designer of the machinery into which the vacuum pump is to be incorporated; see also the note in the EU-Declaration of Conformity)

Installation Position and Space

- Make sure that the environment of the vacuum pump is not potentially explosive
- Make sure that the following ambient conditions will be complied with:
 - Ambient temperature: 12 to 30 °C
 - Ambient pressure: atmospheric
- Make sure that the environmental conditions comply with the protection class of the drive motor (in accordance with the motor name plate)
- Make sure that the vacuum pump will be placed or mounted horizontally
- Make sure that the base for placement / mounting is even
- Make sure that the vacuum pump can neither inadvertently nor intentionally be stepped on and cannot be used as a support for heavy objects
- Make sure that the vacuum pump cannot be hit by falling objects
- Make sure that in order to warrant sufficient cooling, there is a clearance of minimum 0,5 m between the fan cover and nearby walls
- Make sure that no temperature-sensitive parts (plastics, wood, cardboard, paper, electronics) will touch the surface of the vacuum pump
- Make sure that the installation space or location is vented in such a way that sufficient cooling of the vacuum pump is warranted



CAUTION

During operation the surface of the vacuum pump may reach temperatures of more than 100°C.

Risk of burns!

Suction Connection



CAUTION

The ingress of foreign objects or liquids can destroy the vacuum pump.

In case the inlet gas contains dust or other foreign solid particles:

- ◆ Make sure that a suitable filter (5 microns or less) is installed upstream of the vacuum pump

- Make sure that the suction line fits the suction connection/gas inlet (IN) of the vacuum pump
- Make sure that the gas will be drawn through a vacuum-tight flexible hose or a pipe

In case of a pipe being used:

- ◆ Make sure that the pipe will cause no stress on the vacuum pump's connection, if necessary use bellows
- Make sure that the line diameter of the suction line over its entire length is at least as large as the suction connection/gas inlet (IN) of the vacuum pump

In case of very long suction lines, it is prudent to use larger line sizes in order to avoid a loss of efficiency. Please seek the advice from your Busch representative

If two or more vacuum pumps work off the same suction line, if the volume of the vacuum system is large enough to suck back oil or if the vacuum has to be maintained after switching off the vacuum pump:

- ◆ Provide a manual or automatic valve (= non-return valve) in the suction line

(the non-return valve that is installed inside the suction connection is not meant to be used for this purpose!)

- Make sure that the suction line does not contain any foreign objects, e.g. welding slag or swarf

Discharge connection

The following guidelines for the discharge line do not apply if the aspirated air is discharged into the environment right behind the vacuum pump.



CAUTION

If air is discharged into rooms occupied by people, sufficient ventilation must be provided for.

- Make sure that the discharge line fits the gas discharge (OUT) of the vacuum pump

In case of a pipe being used:

- ◆ Make sure that the pipe will cause no stress on the discharge connection, if necessary use bellows
- Make sure that the line diameter of the discharge line over its entire length is at least as large as the gas discharge of the vacuum pump

In case of very long discharge lines, it is prudent to use larger line sizes in order to avoid a loss of efficiency and an overload of the vacuum pump. Please seek the advice from your Busch representative

- Make sure that the discharge line either slopes away from the vacuum pump or provide a liquid separator or a drip leg with a drain cock, so that no condensates can enter the vacuum pump



WARNING

Discharge lines made from non-conducting material can build up static charge.

The discharge line must be made of conducting material or provisions must be made against static charge

Electrical Connection / Controls

- Make sure that the regulations acc. to the EMC-Directive 2014/30/EU as well as the EN-standards, electrical and occupational safety directives and the local or national regulations, are complied with (this is the responsibility of the designer of the machinery into which the vacuum pump is to be incorporated; see also the note in the EU-Declaration of Conformity).
- Make sure that the power supply is compatible with the data on the name plate of the drive motor
- Make sure that an overload protection according to EN 60204-1 is provided for the drive motor

- Make sure that the drive of the vacuum pump will not be affected by electric or electromagnetic disturbance from the mains; if necessary seek advice from the Busch service

In case of mobile installation:

- ◆ Provide the electrical connection with grommets that serve as strain relief

Installation

Mounting

- Make sure that the "Installation Prerequisites" are complied with
- Install or mount the vacuum pump at the location that has been provided for it

Electrical connection



WARNING

Risk of electrical shock, risk of damage to equipment.

Electrical installation work must only be executed by qualified personnel that knows and adheres to the following regulations:

- IEC 364 or CENELEC HD 384 or DIN VDE 0100, respectively,
- IEC-Report 664 or DIN VDE 0110,
- BGV A2 (VBG 4) or corresponding national accident prevention regulation.



CAUTION

The connection schemes given below are considered to be standard. Depending on the specific order or for certain markets, deviating connection schemes may apply.

Risk of damage to the drive motor!

The inside of the terminal box must be checked for drive motor connection instructions/ terminal plans.

- Electrically connect the drive motor
- Connect the earth conductor

Delta connection (Low voltage):

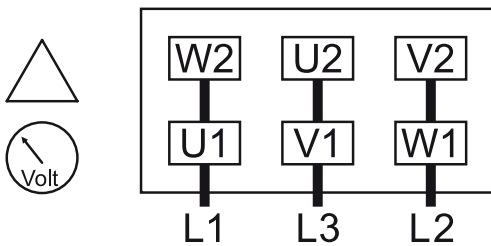

Star connection (High voltage):

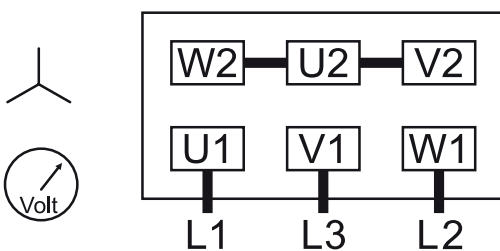

SV/SD 1100 C

Star-star connection, multi-voltage motor (Low voltage):

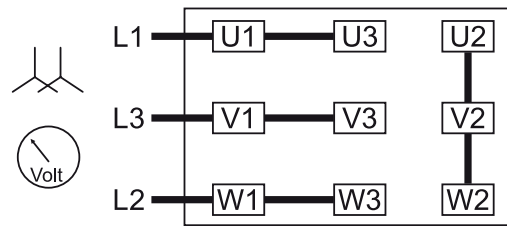

Delta connection, multi-voltage motor (High voltage):

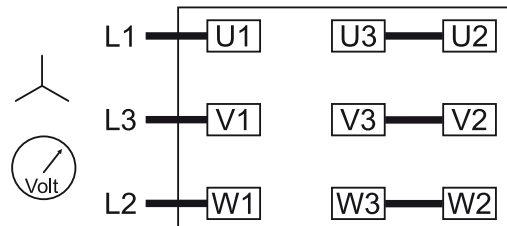



CAUTION

Operation in the wrong direction of rotation, even for a short period of time, can destroy the vacuum pump.

Prior to starting up, make sure that the vacuum pump will operate in the proper direction of rotation.

In the case of portable installation of the vacuum pump, the electrical connection has to be equipped with cable guides in order to prevent undue stresses on the electrical cable.

If the direction of rotation of the fan must be changed:

- ◆ Switch around any two of the drive motor wires in the terminal box

Looking at the motor fan cover, the direction of rotation is clockwise.

Notes on Operation

Application



CAUTION

The vacuum pump is designed for operation under the conditions described below.

In case of disregard, risk of damage or destruction of the vacuum pump!

Risk of Injury!

The vacuum pump must be operated under the conditions described below.

This vacuum pump is designed for

- the suction (SV) or the exhaust (SD)

of

- air and other dry, non-aggressive, non-toxic and non-explosive gases

Conveying media with a higher density than air leads to an increased thermal and mechanical load on the vacuum pump and is permissible only after prior consultation with Busch.

The vacuum pump is made for the intended use in potentially non-explosive areas

Max. permissible number of starts per hour: 12.

The vacuum pump is thermally suitable for continuous operation.

The vacuum pump is leak-tight at ultimate pressure.



CAUTION

This vacuum pump is a dry-running pump.

Do not lubricate the vacuum pump with oil or grease.



CAUTION

During operation the surface of the vacuum pump may reach temperatures of more than 100°C.

Risk of burns!

The vacuum pump shall be protected against contact during operation. Before touching the vacuum pump, wait until it has cooled down sufficiently or wear protective gloves.



CAUTION

Make sure that the installation space or location is vented in such a way that sufficient cooling of the vacuum pump is warranted



CAUTION

The vacuum pump emits noise of medium intensity.

Risk of damage to the hearing.

People staying in the vicinity of a non-noise insulated vacuum pump over extended periods of time must wear suitable ear protection.

Seco rotary vane pumps work absolutely oil free. The vanes are made of special carbon materials and do not need any lubrication.

- Make sure that all provided covers, guards, and protection grids etc. have been fitted
- Make sure that protective devices will not be disabled.
- Make sure that cooling air inlets and outlets are not covered or obstructed and that the cooling air flow is not affected adversely in any other way
- Make sure that the "Installation Prerequisites" (see "Installation Prerequisites and Commissioning" are complied with and will remain so, particularly that there is sufficient cooling at all times.



CAUTION

The SD version is equipped with an pressure relief valve (PRV which has been set to the maximum pressure. This setting must not be changed.

The vacuum pumps have a standard regulating valve.

- Model SV: vacuum regulating valve (VRE)
- Model SD: pressure regulating valve (DV)

During operation of the vacuum pump, the regulation of either pressure or vacuum can be done at any given time. To do this, turn the button of the relevant valve.



CAUTION

When the vacuum pump is switched off whilst still under vacuum, gas may flow back into inlet pipe.

To avoid this, a non-return valve or shut-off valve has to be installed.

Maintenance



CAUTION

Always wear protective clothing when carrying out maintenance work.



CAUTION

During operation the surface of the vacuum pump may reach temperatures of more than 100°C.

Risk of burns!

- Make sure that the vacuum pump is shut down and cannot be accidentally switched on again
- Let the vacuum pump cool down before starting any maintenance work.
- Prior to disconnecting pipework make sure that the connected pipes/lines are vented to atmospheric pressure

Maintenance Schedule

NOTE: The maintenance intervals depend very much on the individual operating conditions. The intervals given below have to be considered as starting values which should be shortened or extended as appropriate. Particularly heavy duty operation, such as high dust loads in the environment or in the process gas, other contaminations or ingress of process material, can make it necessary to shorten the maintenance intervals significantly.

Every 6 Months:

- Make sure that the vacuum pump is shut down and locked against inadvertent start up
- Check the suction lines for contamination or blockages.
- Check the cooling coils and the fan cover regularly for dirt, clean when necessary.
A dirty fan cover or cooling coils prevent the proper intake of cooling air which can lead to overheating of the vacuum pump.
- The electrical connections must be checked by a specialist.

Every 100 - 500 Operating hours

- Clean the inlet filter on the suction side at regular intervals. The cleaning intervals depend on the quantity of dust contained in the drawn air
 - ◆ If the filter is too dirty to be cleaned:
Remove the cover and replace the filter

Every 1000 Operating hours

- Check the vanes, for the first time after 2000 operating hours (see "Carbon vanes")

Every 1000 - 2000 Operating hours

- Replacing the outlet filter (SD version only). To do this, lift the cover (see "Suction filter and outlet filter")

The bearings are pre-lubricated for life and will thus not require maintenance. Replace by original roller bearings only

Inlet filter and pressure filter (SD)

The inlet filter and the pressure filter must be cleaned at regular intervals, depending on the amount of dust in the air being pumped. Blow out the filter cartridges with compressed air from the inside out. If the cartridge is too dirty to be cleaned, it must be replaced. The cartridges can be taken out after the removal of the filter cover.

Vaness

The lifetime of the carbon vanes (VA) depends on the application of the vacuum pump. If the width of the vane reaches the given limit for re-placement, it is necessary to change the vanes. Remove the filter cover and the cylinder endplate to change the vanes. Blow out the compression chamber with dry compressed air. Make sure that the vanes are positioned correctly and the right way round (curved edge facing the cylinder wall).

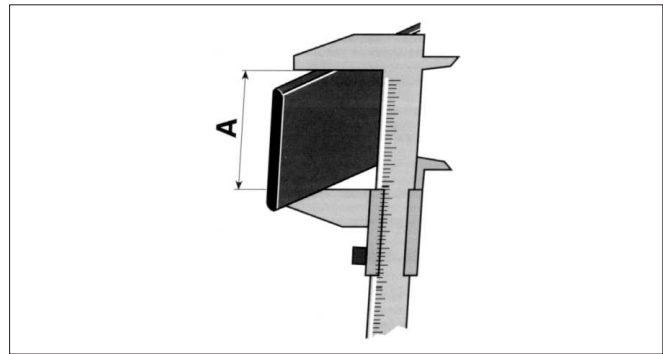

Pump type	Width of vanes minimum A
SV/ SD 1100 C	26 mm

Overhaul



CAUTION

In order to achieve best efficiency and a long life of operation, the vacuum pump has been assembled and adjusted with specifically defined tolerances.

This adjustment will be lost during dismantling of the vacuum pump.

It is therefore strictly recommended that any dismantling of the vacuum pump that goes beyond of what is described in this manual must be done by the Busch service.



CAUTION

Improper work on the vacuum pump will put the operating safety at risk.

Risk of explosion!

Approval for operation of the vacuum pump will be void!

Any dismantling of the vacuum pump that goes beyond of what is described in this manual must be done by specially trained Busch service personnel only.

Removal from Service

Temporary Removal from Service

- Prior to disconnecting pipes/lines, make sure that all pipes/lines are vented to atmospheric pressure

Recommissioning



CAUTION

Vaness can stick after a long period of standstill.

Risk of vane breakage if the vacuum pump is started with the drive motor.

After longer periods of standstill, the vacuum pump must be turned by hand.

After longer periods of standstill:

- ◆ Make sure that the vacuum pump is shut down and cannot be accidentally switched on again
- ◆ Remove the fan cover of the drive motor
- ◆ Slowly rotate the fan by hand in the intended direction of rotation
- ◆ Refit the fan cover of the drive motor

If it is suspected that deposits could have gathered in the vacuum pump:

- ◆ Clean using dry compressed air
- Observe the chapter "Installation and Commissioning"

Dismantling and Disposal

- Make sure that all materials and components to be treated as special waste have been separated from the vacuum pump

According to the best knowledge at the time of print of this manual, the materials used for the manufacture of the vacuum pump involve no risk.

- Dispose of special waste in compliance with applicable regulations
- Dispose of the vacuum pump as scrap metal

Troubleshooting



WARNING

Risk of electrical shock, risk of damage to equipment.

Electrical installation work must only be carried out by qualified personnel that knows and adheres to the following regulations:

- IEC 364 or CENELEC HD 384 or DIN VDE 0100, respectively,
- IEC-Report 664 or DIN VDE 0110,
- BGV A2 (VBG 4) or equivalent national accident prevention regulations.



CAUTION

During operation, the surface of the vacuum pump may exceed temperatures of 100°C.

Risk of burns!

Do not touch the hot surfaces of the vacuum pump.

Please contact your local Busch representative if you have any doubts or questions

Problem	Possible Cause	Remedy
<p>The vacuum pump does not reach the usual working pressure</p> <p>The amperage of the motor is too high (compared with the initial values after commissioning)</p> <p>Reaching operational pressure takes too long</p>	The vacuum system or suction lines are not leak-tight	Check piping, hoses or pipe connections for any possible leaks
	The exhaust filter is dirty	Replace the exhaust filter (see "Maintenance")
	In case an inlet filter is installed on the suction side (IN): The filter on the suction side (IN) is partially clogged	Clean or change the filter
	Partial clogging or blockage in suction or discharge lines	Remove foreign particles
	Suction or discharge lines too long or too small (diameter)	Use larger diameter lines
	The disc of the non-return valve (SD) at the inlet is (fully or partially) jammed in closed position	Dismantle the inlet, clean the valve and reassemble
	A pressure valve is jammed in a partially open position	Dismantle, clean, check and reassemble the pressure valve (Busch service)
	A vane (VA) is jammed in the rotor or damaged	Free the vanes or replace them with new ones (Busch service)
	The radial clearance between the rotor (RT) and the cylinder is no longer correct	Reset the clearances in the vacuum pump (Busch service)
	Internal parts of the vacuum pump worn or damaged	Have the vacuum pump repaired (Busch service)
The vacuum pump does not start	The drive motor is not supplied with the correct voltage or is overloaded	Supply the drive motor with the correct voltage
	The drive motor trip switch protection is too weak or trip level is set too low	<p>Compare the technical data of the drive motor trip switch with the data on the name plate of the motor.</p> <p>Correct if necessary</p> <p>In case of high ambient temperature: Set the trip level of the drive motor trip switch 5% above the nominal drive motor current</p>
	One of the fuses has blown	Check the fuses

	The electrical connection cable is too long or its diameter too small causing a voltage drop at the vacuum pump	Use an adequately dimensioned cable
	The vacuum pump or the drive motor is jammed or seized	Make sure that the drive motor is disconnected from the power supply Remove the fan cover Try to turn the fan by hand If the unit vacuum pump / drive motor is still jammed: Remove the drive motor and check the drive motor and the vacuum pump separately If the vacuum pump is jammed: Have the vacuum pump repaired (Busch service)
	The drive motor is defective	Change the drive motor (Busch service)
The vacuum pump is jammed or seized	Broken vanes	Have the vacuum pump repaired (Busch service) Check the process
	The vacuum pump was operated in the wrong direction of rotation	Have the vacuum pump repaired (Busch service) When connecting the vacuum pump, make sure the vacuum pump will run in the correct direction of rotation (see "Installation")
The vacuum pump starts, but runs noisily or not as it should The amperage of the motor is too high (compared with the initial value after commissioning)	The motor winding is defective The drive motor operates on two phases only	Check the proper connection of the wires against the wiring diagram Tighten or change the connections
	The vacuum pump runs in the wrong direction (of rotation)	Check rotation of the drive motor. See "Installation and Commissioning", change if necessary
	Standstill of the vacuum pump over several weeks or months in a damp environment	Switch on the vacuum pump and let it warm up with the inlet closed
	Broken vanes Seized bearings	Have the vacuum pump repaired (Busch service)
The vacuum pump is very noisy	Defective bearings	Have the vacuum pump repaired (Busch service)
	Stuck vanes	Have the vacuum pump repaired (Busch service)
The vacuum pump is very hot	Insufficient ventilation	Make sure that the cooling of the vacuum pump is not impaired by dust/dirt Clean the fan cover, fans, ventilation grids and cooling fins Install the vacuum pump in a narrow space only if sufficient ventilation can be guaranteed
	Ambient temperature too high	Keep within the permitted ambient temperature range
	Temperature of the drawn gases too high	Keep within the permitted temperature range for the drawn gases
	The exhaust filters are partially clogged (SD/DC)	Replace exhaust filters (SD/ DC)
	Mains frequency or mains voltage outside tolerance range	Provide a more stable power supply
	In case an inlet filter is installed on the suction connection (IN) : The filter on the suction connection (IN) is partially clogged	Clean or replace the filter

	Partial clogging or blockage in suction or discharge lines	Remove foreign particles
	Suction or discharge lines too long, or too small (diameter)	Use larger diameter lines

Exploded view

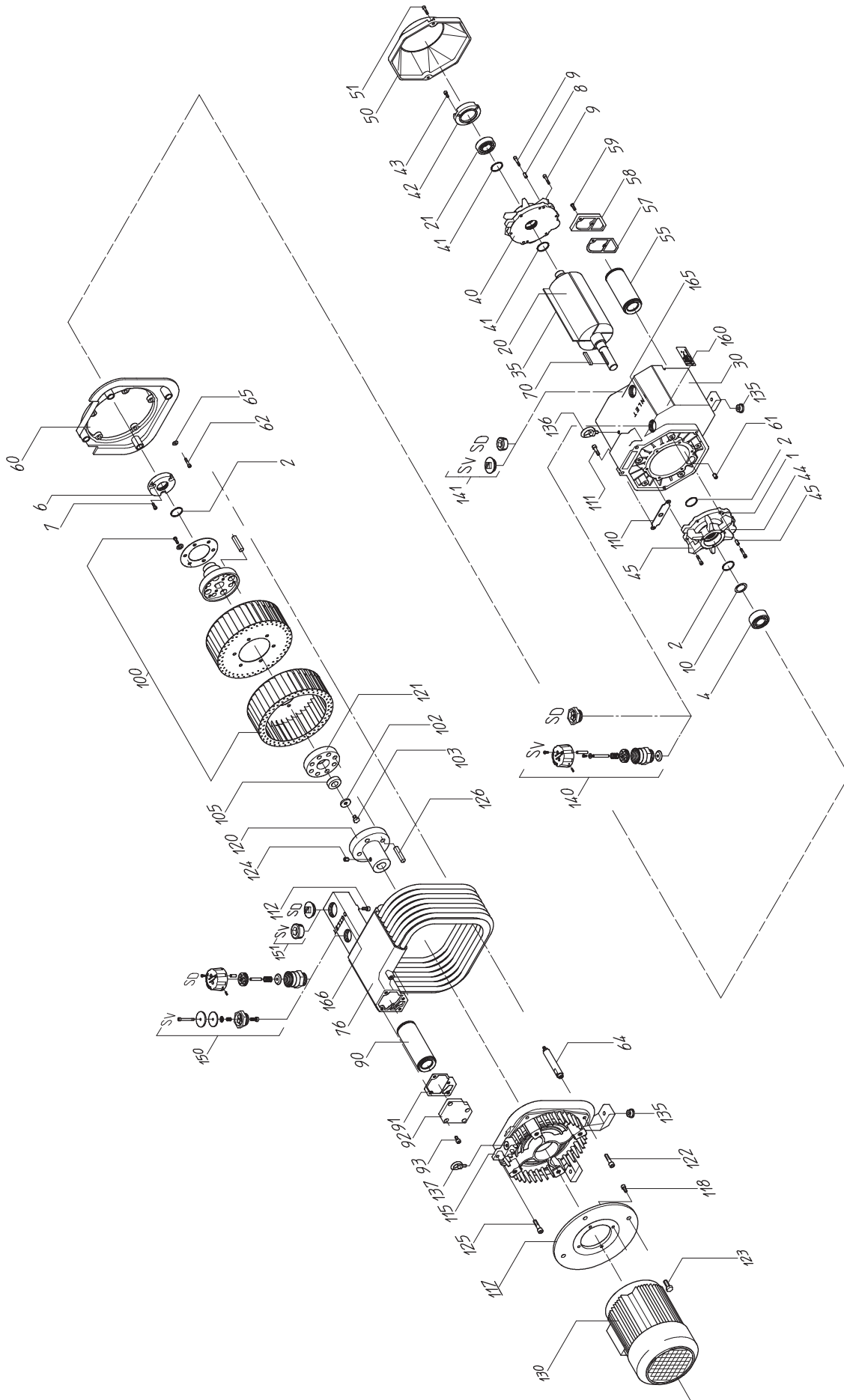

Spare parts

NOTE: When ordering spare parts or accessories acc. to the table below, please always quote the type and the serial no. of the vacuum pump (on the name plate of the pump). This will allow Busch service technicians to check if the vacuum pump is compatible with a modified or improved part.

The exclusive use of genuine spare parts and consumables is a prerequisite for the proper function of the vacuum pump and for the granting of warranty, guarantee or goodwill.

This parts list applies to a typical and standard configuration of the vacuum pump. Specific pump configuration parts lists can be supplied upon request, and after quoting the serial number of the pump concerned.

Gasket kit

The gasket kits contain all the seals to be changed during service work on a vacuum pump.

Part number : 0990 501 666			
Pos.	Part	Qt	SV 1100 C/ SD 1100 C
2	Tube	1,2 m	0570 000 188
57	Seal	1	0482 500 089
91	Seal	1	0482 500 111

Full service kit

The full service kits contain all relevant gasket kits as well as the parts subjected to wear and tear that need to be changed.

Part number : 0993 506 675			
Pos.	Part	Qt	SV1100 C / SD 1100 C
4	Ball bearing	1	0473 500 356
21	Cylindrical roller bearing	1	0473 000 121
35	Vane	4	0722 500 122
55	Filter cartridge	1	0532 500 080
90	Filter cartridge	1	0532 500 081
121	Clutch disk	1	0512 000 140
-	Gasket kit	1	0990 501 666

Accessories

Accessories	SV 1100 C
Air filter	0945 501 916
Non-return valve	0947 504 331

Technical data

Technical data			SV 1100 C	SD 1100 C
Nominal displacement	50 (60) Hz	m ³ /h	100 (120)	
Ultimate pressure		hPa (abs.)	100	-
Overpressure		hPa (abs.)	-	2500
Nominal motor rating	50 (60) Hz	kW	3 (4)	5,5 (7,5)
Nominal motor speed	50 (60) Hz	min ⁻¹	1500 (1800)	
Sound level (EN ISO 2151)	50 (60) Hz	dB(A)	75 (76)	77 (78)
Ambient pressure			Atmospheric pressure	
Weight approx.	50 (60) Hz	kg	111 (122)	129 (141)

EU Declaration of Conformity

This Declaration of Conformity and the CE-mark affixed to the nameplate are valid for the machine within the Busch scope of delivery. This Declaration of Conformity is issued under the sole responsibility of the manufacturer. When this machine is integrated into a superordinate machinery the manufacturer of the superordinate machinery (this can be the operating company, too) must conduct the conformity assessment process for the superordinate machine or plant, issue the Declaration of Conformity for it and affix the CE-mark.

The manufacturer

Busch Výroba CZ s.r.o
Svárovská 620
CZ 460 01, Liberec 11

declares that the machine(s): **SECO SV/SD 1100 C**

fulfil(s) all the relevant provisions from European directives:

- 'Machinery' 2006/42/EC
- 'Electromagnetic Compatibility' 2014/30/EU
- 'RoHS' 2011/65/EU Restriction of the use of certain hazardous substances in electrical and electronic equipment (incl. all related applicable amendments)

and comply(-ies) with the following designated standards that have been used to fulfil those provisions:

Standard	Title of the Standard
EN ISO 12100 : 2010	Safety of machinery - Basic concepts, general principles of design
EN ISO 13857 : 2019	Safety of machinery - Safety distances to prevent hazard zones being reached by the upper and lower limbs
EN 1012-1 : 2010 EN 1012-2 : 1996 + A1 : 2009	Compressors and vacuum pumps - Safety requirements - Part 1 and Part 2
EN ISO 2151 : 2008	Acoustics - Noise test code for compressors and vacuum pumps - Engineering method (grade 2)
EN 60204-1: 2018	Safety of machinery - Electrical equipment of machines - Part 1: General requirements
EN IEC 61000-6-2 : 2019	Electromagnetic compatibility (EMC) - Generic standards. Immunity for industrial environments
EN IEC 61000-6-4 : 2019	Electromagnetic compatibility (EMC) - Generic standards. Emission standard for industrial environments
EN ISO 13849-1 : 2015 ⁽¹⁾	Safety of machinery - Safety-related parts of control systems - Part 1: General principles for design

⁽¹⁾ In case control systems are integrated.

Legal person authorized to compile the technical file
and authorized representative in the EU
(if the manufacturer is not located in the EU):

Busch Dienste GmbH
Schauinslandstr. 1
DE-79689 Maulburg

Liberec, 14.05.2021



Michael Dostálek, General Director

UK Declaration of Conformity

This Declaration of Conformity and the UKCA-mark affixed to the nameplate are valid for the machine within the Busch scope of delivery. This Declaration of Conformity is issued under the sole responsibility of the manufacturer. When this machine is integrated into a superordinate machinery the manufacturer of the superordinate machinery (this can be the operating company, too) must conduct the conformity assessment process for the superordinate machine or plant, issue the Declaration of Conformity for it and affix the UKCA-mark.

The manufacturer

Busch Výroba CZ s.r.o
Svárovská 620
CZ 460 01, Liberec 11

declares that the machine(s): **SECO SV/SD 1100 C**

fulfil(s) all the relevant provisions from UK legislations:

- Supply of Machinery (Safety) Regulations 2008
- Electromagnetic Compatibility Regulations 2016
- Restriction of the use of certain hazardous substances in electrical and electronic equipment Regulations 2012

and comply(-ies) with the following designated standards that have been used to fulfil those provisions:

Standard	Title of the Standard
BS EN ISO 12100 : 2010	Safety of machinery. Basic concepts, general principles of design. Risk assessment and risk reduction.
BS EN ISO 13857 : 2019	Safety of machinery - Safety distances to prevent hazard zones being reached by the upper and lower limbs.
BS EN 1012-1 : 2010 BS EN 1012-2 : 1996 + A1 : 2009	Compressors and vacuum pumps. Safety requirements. Air compressors and vacuum pumps.
BS EN ISO 2151 : 2008	Acoustics - Noise test code for compressors and vacuum pumps - Engineering method (grade 2)
BS EN 60204-1 : 2018	Safety of machinery. Electrical equipment of machines. General requirements.
BS EN IEC 61000-6-2 : 2019	Electromagnetic compatibility (EMC) - Generic standards. Immunity standard for industrial environments.
BS EN IEC 61000-6-4 : 2019	Electromagnetic compatibility (EMC) - Generic standards. Emission standard for industrial environments.
BS EN 13849-1 : 2015 ⁽¹⁾	Safety of machinery. Safety-related parts of control systems. General principles for design.

⁽¹⁾ In case control systems are integrated.

Legal person authorized to compile the technical file
and importer in the UK
(if the manufacturer is not located in the UK):

Busch (UK) Ltd
30 Hortonwood
Telford - UK

Liberec, 14.05.2021



Michael Dostálek, General Director

Note

Busch

Vacuum Solutions

We shape vacuum for you.

Argentina

info@busch.com.ar

Australia

sales@busch.com.au

Austria

busch@busch.at

Bangladesh

sales@busch.com.bd

Belgium

info@busch.be

Brazil

vendas@buschdobrasil.com.br

Canada

info@busch.ca

Chile

info@busch.cl

China

info@busch-china.com

Colombia

info@buschvacuum.co

Czech Republic

info@buschvacuum.cz

Denmark

info@busch.dk

Finland

info@busch.fi

France

busch@busch.fr

Germany

info@busch.de

Hungary

busch@buschvacuum.hu

India

sales@buschindia.com

Ireland

sales@busch.ie

Israel

service_sales@busch.co.il

Italy

info@busch.it

Japan

info@busch.co.jp

Korea

busch@busch.co.kr

Malaysia

busch@busch.com.my

Mexico

info@busch.com.mx

Netherlands

info@busch.nl

New Zealand

sales@busch.co.nz

Norway

post@busch.no

Peru

info@busch.com.pe

Poland

busch@busch.com.pl

Portugal

busch@busch.pt

Romania

office@buschromania.ro

Russia

info@busch.ru

Singapore

sales@busch.com.sg

South Africa

info@busch.co.za

Spain

contacto@buschiberica.es

Sweden

info@busch.se

Switzerland

info@buschag.ch

Taiwan

service@busch.com.tw

Thailand

info@busch.co.th

Turkey

vakutek@ttmail.com

United Arab Emirates

sales@busch.ae

United Kingdom

sales@busch.co.uk

USA

info@buschusa.com