

# TAPIR

Helium Leak Detector  
HL 1102 A

## Instruction Manual



# Table of contents

<b>1</b>	<b>About this manual</b>	<b>5</b>
1.1	Validity	5
1.1.1	Applicable documents	5
1.2	Target group	6
1.3	Conventions	6
1.3.1	Safety instructions	6
1.3.2	Pictographs	7
1.3.3	Instructions/Abbreviations used	7
1.3.4	Labels	7
<b>2</b>	<b>Safety</b>	<b>9</b>
2.1	Safety precautions	9
2.2	Protective equipment	10
2.3	Proper use	10
2.4	Improper use	11
<b>3</b>	<b>Transport and storage</b>	<b>12</b>
3.1	Transport	12
3.2	Storage	12
3.3	Transport and handling	13
3.3.1	Transport	13
3.3.2	Handling	13
<b>4</b>	<b>Product description</b>	<b>15</b>
4.1	Product identification	15
4.2	Scope of delivery	15
4.3	Interface connection	16
<b>5</b>	<b>Installation</b>	<b>17</b>
5.1	Prerequisites for optimising measurement	17
5.2	Operating conditions	17
5.3	Set-up	17
5.3.1	Use positions	18
5.3.2	Control panel fixing	18
5.3.3	Fixture of the cart	18
5.4	Neutral gas purge and inlet vent connection	18
5.5	Connection to the mains power supply	19
5.6	Operating for the first time	19
5.6.1	Familiarise yourself with the control panel	19
5.6.2	Become familiar with the detector	19
5.7	Connecting the part/installation to be tested	20
5.8	Connecting the exhaust	20
<b>6</b>	<b>Operation</b>	<b>21</b>
6.1	Control panel	21
6.1.1	Description	21
6.1.2	Application screens	23
6.1.3	"Standard" screen	24
6.1.4	"Settings" screen	24
6.1.5	"Graph" screen	25
6.1.6	"Vacuum circuit" screen	25
6.1.7	"Measurement" window	25
6.1.8	Function keys	26

6.2	Prerequisites to use	26
6.3	Switching the detector on	26
6.4	Starting a test	27
6.4.1	Hard vacuum test method	27
6.4.2	Sniffing test method	27
6.5	Calibration	28
6.5.1	Calibration with the internal calibrated leak	28
6.5.1	Calibration with an external calibrated leak	29
6.5.3	Calibration procedure with external leak in Hard Vacuum test.	29
6.5.4	Calibration with a pumping system in parallel	30
6.6	Monitoring operation	31
6.7	Shutdown the detector	31
6.8	Saving and downloading the product's configuration	31
6.8.1	Saving the configuration	31
6.8.2	Downloading the configuration	31
<b>7</b>	<b>Advanced settings.</b>	<b>32</b>
7.1	"Graph" screen	32
7.1.1	Description	32
7.1.2	Settings	32
7.1.3	Scales setting	32
7.1.4	Graph clearing	33
7.1.5	Recording	33
7.1.6	Saving a recording	34
7.1.7	Viewing a recording	35
7.2	Tree diagram of the "Settings" menu	37
7.2.1	Tree diagram of the "Set points" menu	37
7.2.2	Tree diagram of the "Test" menu	38
7.2.3	Tree diagram of the "Spectro" menu	38
7.2.4	Tree diagram of the "Maintenance" menu.	39
7.2.5	Tree diagram of the "Configuration" menu	40
7.2.6	Tree diagram of the "Advanced" menu.	41
7.3	Set points Menu	43
7.3.1	Audio alarm and digital voice	43
7.3.2	Pollution function.	43
7.3.3	Hard Vacuum reject point	44
7.3.4	Sniffing reject set point	44
7.3.5	Probe clogged set point	44
7.4	Test Menu	45
7.4.1	Test method.	45
7.4.2	Correction factor	45
7.4.3	Test mode	46
7.4.4	Automatic Cycle End	46
7.4.5	Inlet vent	47
7.4.6	Memo function.	47
7.4.7	Zero activation.	48
7.5	Spectro Menu	49
7.5.1	Tracer gas	49
7.5.2	Filament parameters	49
7.5.3	Calibrated leak	49
7.6	Maintenance Menu	50
7.6.1	Detector.	50

7.6.2	Timers . . . . .	50
7.6.3	Detector Information . . . . .	51
7.6.4	Pump Information . . . . .	51
7.6.5	Event history . . . . .	52
7.6.6	Calibration history . . . . .	53
7.7	Configuration Menu. . . . .	53
7.7.1	Time - Date - Unit - Language. . . . .	53
7.7.2	Function keys . . . . .	53
7.7.3	Application screens. . . . .	55
7.7.4	Screen Settings. . . . .	56
7.7.5	Access - Password . . . . .	56
7.8	Advanced Menu . . . . .	60
7.8.1	Leak Detection Menu . . . . .	60
7.8.2	Leak Detection: Start-up timer. . . . .	60
7.8.3	Leak Detection: Background suppression . . . . .	60
7.8.4	Leak Detection: Crossover Pressures. . . . .	60
7.8.5	Leak Detection: Calibration . . . . .	61
7.8.6	Leak Detection: Analyzer cell . . . . .	62
7.8.7	Leak Detection: Internal Pirani gauge calibration . . . . .	62
7.8.8	Input/Output menu . . . . .	62
7.8.9	Input/Output: Serial Link 1 and Serial Link 2. . . . .	63
7.8.10	Input/Output: I/O connector. . . . .	63
7.8.11	SD Card menu . . . . .	63
7.8.12	Service . . . . .	64
<b>8</b>	<b>Maintenance / replacement. . . . .</b>	<b>65</b>
8.1	Maintenance intervals and responsibilities . . . . .	65
<b>9</b>	<b>Service . . . . .</b>	<b>66</b>
<b>10</b>	<b>Accessories . . . . .</b>	<b>67</b>
<b>11</b>	<b>Technical data and dimensions . . . . .</b>	<b>68</b>
11.1	General . . . . .	68
11.2	Technical data . . . . .	68
11.3	Units of measurement. . . . .	68
11.4	Dimensions . . . . .	70
	<b>EU Declaration of Conformity. . . . .</b>	<b>71</b>
	<b>UK Declaration of Conformity. . . . .</b>	<b>72</b>

# 1 About this manual



## IMPORTANT

Read carefully before use.  
Keep the manual for future consultation.

## 1.1 Validity

This operating manual is for customers of Busch. It describes the functioning of the designated product and provides the most important information for safe use of the unit. The description follows applicable EU guidelines. All information provided in this operating manual refers to the current state of the product's development. The documentation remains valid as long as the customer does not make any changes to the product.

Up-to-date operating instructions can also be downloaded from [www.buschvacuum.com](http://www.buschvacuum.com).

This manual covers products with the following part numbers:

Part number	Description
0659230705	TAPIR HL 1102 A Leak detector

### 1.1.1 Applicable documents

Documents relevant for the use of options and/or accessories, and for product maintenance are the following:

TAPIR HL 1102 A	Operating instructions
RS232 Operating Instructions	P/n 0870223377*
Operating instructions for the 15 pin I/O board	P/n 0870223372*
Sniffer Probe Operating instructions	P/n 0870230738*
Spray Gun Operating instructions	P/n 0870230736*
TAPIR HL 1102 A Maintenance instructions	P/n 0870223375*
EU-Declaration of conformity	Included with this manual

\*also available at [www.buschvacuum.com](http://www.buschvacuum.com)

## 1.2 Target group

This user manual is intended for all persons in charge of transport, installation, commissioning/decommissioning, use, maintenance or storage of the product.

The work described in this document must only be carried out by persons with suitable technical training (specialized staff) or persons who have undergone Busch training.

## 1.3 Conventions

### 1.3.1 Safety instructions

Operating manual safety instructions Busch are based on the UL, CSA, ANSI Z-535, SEMI S2, ISO 3864 and DIN 4844 certification standards. This document describes the following information and danger levels:

<b>DANGER</b>
<b>Imminent danger</b> Indicates an imminent hazardous situation that will result in death or serious injury.
<b>WARNING</b>
<b>Possibly imminent danger</b> Indicates an imminent hazardous situation that can result in death or serious injury.
<b>CAUTION</b>
<b>Possibly imminent danger</b> Indicates an imminent hazardous situation that can result in minor or moderate injury.
<b>NOTICE</b>
<b>Command or note</b> Command to perform an action or information about properties, the disregarding of which may result in damage to the product.

### 1.3.2 Pictographs



Prohibition of an action to avoid any risk of accidents, the disregarding of which may result in serious accidents



Warning of a displayed source of danger in connection with operation of the unit or equipment



Command to perform an action or task associated with a source of danger, the disregarding of which may result in serious accidents



Note



Tip

### 1.3.3 Instructions/Abbreviations used



Work instruction: you must perform an operation here.



You must press the **XXXX** key on the control panel.



Example: press the "Home" key on the control panel to return to the «Standard» screen.

I/O

Inputs/Outputs

<sup>4</sup>He

Helium 4

<sup>3</sup>He

Helium 3

H<sub>2</sub>

Hydrogen

### 1.3.4 Labels

This chapter lists all the labels that could appear on the product as well as their meaning.

FR AEOF 00165062 - assurance qualité / quality control

Safety label: guarantee that the packing has not been opened since leaving the factory.



Indicates that the operator must:

- ⇒ handle the product using the devices shown on this label,
- ⇒ comply with the rules for moving the equipment, taking weight and dimensions into account.



Indicates an electric shock hazard in case of contact:

- ⇒ do not use the product if the power cable is not earthed,
- ⇒ disconnect the electrical power supply before working on the product.



Indicates an electrical shock hazard in case of contact:

- ⇒ disconnect the electrical power supply before removing the cover and working on the product.



Locate a grounding point on the product.

**THIS PRODUCT COMPLIES  
WITH OUR  
FINAL QUALITY TESTS**

Quality: certifies that the product has been certified compliant with quality control upon leaving the factory.

Pu_GL : 1	Pu_N : 1
Mu_GL : 12856	M
-----	
Mu_Cal : 1	Mu_LDS : 1800

For service centers use only.

DD-MM-YY <sup>④</sup>		
<b>Factory Firmware /Logiciel usine</b>		
L0232	V3302	E17D
L0264	V3200	FD87E7D
L0285	V3200	8C9D
①	②	③

Indicates the firmware versions installed on the product.

- 1) Firmware name
- 2) Firmware version
- 3) Firmware checksum
- 4) Publication date



Product subject to the treatment of waste electronic and electrical equipment in accordance with directive 2012/19/EU

<b>BU-SCH</b>		Busch Produktions GmbH Schauinslandstraße 1 79689 Maulburg	1	<b>CE</b>
		Made in France		
Leak Detector		Year YYYY	<b>2</b>	
TAPIR HL 1102 A	<b>3</b>	P/N =	<b>4</b>	
S/N =	<b>5</b>	m =	<b>6</b>	
P =	<b>7</b>		<b>8</b>	
				<b>9</b>

Product identification label:

<b>Nameplate example</b>	
<b>1</b>	Manufacturer
<b>2</b>	Date of manufacture
<b>3</b>	Product name
<b>4</b>	Part number
<b>5</b>	Serial number
<b>6</b>	Weight
<b>7</b>	Maximum power consumption
<b>8</b>	Power supply
<b>9</b>	Barcode



## 2 Safety

### 2.1 Safety precautions



#### Obligation to inform

Any person responsible for installing, using or maintaining the product must first read the security instructions in this operating manual and comply with them.

→ It is the operating customer's responsibility to protect all operators against the dangers associated with the product, with the media pumped and with the entire installation.



#### Installation and use of the accessories

The products can be fitted with special accessories. The installation, use and refurbishment of the connected accessories are described in detail in the respective manuals.

→ Only use original accessories.

→ Accessory part numbers: see **Accessories**.



#### WARNING

#### Hazard associated with non-compliant electrical installation

Safe operation after installation is the operator's responsibility.

→ Connect the product to an installation that is compliant with local safety standards.

→ Do not carry out any alterations or modifications to the product on your own initiative.

→ For specific questions, contact your service center.



#### WARNING

#### Electric shock hazard in case of contact

When the product's circuit breaker is set at **O**, some internal components still have an electrical charge.

→ Make sure that the mains connection is always visible and accessible so that it can be unplugged at any time.

→ Disconnect the power cable from all power sources before starting any work on the product.



#### WARNING

#### Other localized hazardous energies

Electrical circuit and other pressurized circuits as nitrogen are potential hazards:

→ Always lock out these energy sources before working on the product.



#### WARNING

#### Risk associated with process gases

A leak detection operation must be carried out under environmental conditions that do not present any risks to the operator and the equipment. The user and/or integrator of the product are fully responsible for the operational safety conditions of the equipment. Therefore the user of the detector must:

→ not test parts or equipment with traces of harsh, chemical, corrosive, inflammable, reactive, toxic, or explosive substances, nor condensable vapours even in small amounts. Do not use the nitrogen purge system to dilute these hazardous products: that is not what it is intended for!

→ apply specific safety instructions in accordance with local regulations. For more information, contact your service center.

The potential hazards for a leak detector involve electricity, the tracer gas and the pressurised nitrogen supply.

- Only qualified personnel trained in safety rules (EMC, electrical safety, chemical pollution) may carry out the installation and maintenance described in this manual. Our service centers can provide the necessary training.
- Do not remove the blanked-off flange from the inlet port while the product is not in use.
- Do not expose any part of the human body to the vacuum.
- Comply with all safety and risk prevention instructions in accordance with local safety standards.
- Regularly check compliance with all precautionary measures.
- Do not turn on the product if the covers are not in place.

## 2.2 Protective equipment

In some situations, personal protective equipment must be worn when handling the detector and its components. Customers must provide operators with the necessary equipment. This equipment must be checked regularly and used in accordance with the supplier's recommendations.



<b>WARNING</b>	
<b>Risk of injury due to falling objects</b>	<p>When transporting parts/components and during maintenance there is a danger of loads slipping and falling down.</p> <ul style="list-style-type: none"> <li>→ Carry small and medium-size parts/components with both hands.</li> <li>→ Carry parts/components &gt; 20 kg with a suitable lifting device.</li> <li>→ Wear safety shoes with a steel toe in accordance with directive EN 347.</li> </ul>



<b>WARNING</b>	
<b>Risk of injury through falling objects</b>	<p>When transporting parts/items by hand, there is a danger through loads slipping and falling down.</p> <ul style="list-style-type: none"> <li>→ Carry small and mid-size parts/items two-handed.</li> <li>→ Carry parts/items &gt; 20 kg with a suitable lifting device.</li> <li>→ Wear safety shoes with steel toe cap according to directive EN 347.</li> </ul>



<b>WARNING</b>	
<b>Risk of injury through hot surfaces</b>	<p>The products are designed so as not to present a thermal risk for the operator's safety. However, specific operating conditions may exist that require extra caution from users due to the high temperatures (surfaces &gt; 70 °C for parts inside the covers).</p> <ul style="list-style-type: none"> <li>→ Leave the part to cool before working on the product.</li> <li>→ If necessary wear protective gloves according to directive EN 420.</li> </ul>

## 2.3 Proper use



<b>NOTICE</b>	
<b>EC conformity</b>	<p>The manufacturer's declaration of conformity becomes invalid if the operator modifies the original product or installs additional components.</p> <ul style="list-style-type: none"> <li>→ Following installation into a plant and before commissioning, the operator must check the entire system for compliance with the valid EU directives and reassess it accordingly.</li> </ul>

- The leak detector is designed to detect and/or quantify a possible installation or component leak by searching for the presence of a tracer gas in the pumped gases.

- Only the tracer gases identified in this manual may be used.
- The parts to be tested must imperatively be clean and dry.
- The product may be used in an industrial environment.

## 2.4 Improper use

Improper use will cause all claims for liability and warranties to be forfeited. Improper use is defined as usage for purposes deviating from those mentioned above, especially:

- pumping harsh, chemical, corrosive, inflammable, reactive, toxic or explosive fluids
- pumping of liquids
- pumping of condensing vapors
- pumping dust or solids
- operation in potentially explosive areas
- analysis of gas with a hydrogen concentration higher than 5 %
- testing parts that are soiled or that have traces of water, vapours, paint, adhesive, detergent or rinsing products
- use of accessories or spare parts, which are not named in this manual

The product is not designed to carry people or loads and is not for use as a seat, step-ladder or any other similar purpose.

### 3 Transport and storage

Upon delivery, check that the product has not been damaged during transport. If the product is damaged, take the necessary measures with the carrier and notify the manufacturer. In all situations we recommend:

- Keeping the product in its original packaging so it stays as clean as it was when dispatched by us. Only unpack the product once it has arrived at the location where it will be used.
- Keeping the packaging (recyclable materials) in case the product needs to be transported or stored.
- Keeping the blanked-off plate on the inlet port when the product is not in use.

#### 3.1 Transport



<b>WARNING</b>
<p><b>Risk of tilting</b></p> <p>Even though compliance with EEC safety rules is guaranteed (normal tilting <math>\pm 10^\circ</math>), all necessary precautions should be taken when moving, installing and operating the product.</p> <p>When the detector is used on the trolley (accessory):</p> <ul style="list-style-type: none"> <li>→ Attach the detector to the trolley.</li> <li>→ Do not place the product on an inclined plane: its weight could cause the operator to be dragged.</li> <li>→ Place it on a flat, hard floor.</li> <li>→ Do not push the product sideways.</li> <li>→ Only use the trolley to move it short distances.</li> </ul>



<b>NOTICE</b>
<p><b>Work/Handling the detector</b></p> <p>The operator must not work on the product to move it or carry out maintenance until it has come to a complete shutdown! When the circuit breaker is set at <b>O</b>, you must:</p> <ul style="list-style-type: none"> <li>→ Unplug the power cable.</li> <li>→ Wait for the control panel screen to turn off completely before working on the product and/or removing the covers.</li> </ul>

#### 3.2 Storage



<b>NOTICE</b>
<p><b>Obligation to inform</b></p> <p>We took care to provide you with a clean product. So that it stays clean, we recommend storing it in its original packaging.</p>



**Storing a new product**

If a new detector must be stored for more than three months:

- leave it in its packaging,
- leave the blanked-off flange in place on each port,
- store it in a clean, dry environment for a maximum of 3 months, in accordance with the temperature conditions specified in the **Technical Characteristics** (see 11.2).

**Extended storage**

Recommended shutdown procedure before extended storage:

- Place the blanked-off flange on the inlet port.
- In the menu **[Test]**, check:
  - that the 'hard vacuum' test method is selected,
  - that the air inlet valve is set to 'Operator'
- Start a test by pressing  : wait until the detector reaches the most sensitive test mode.
- Make sure that the inlet vent is inactive.
- Stop the test by pressing .
- Shut down the detector: circuit breaker **MS** to **O**.
- After the control panel screen has completely extinguished, wait 2 minutes before working on the product, removing the covers and/or moving it.
- Unplug the power cable.

In this way, the detector is under a vacuum, reducing the degassing time spent when it is switched on again.

### 3.3 Transport and handling

#### 3.3.1 Transport

We recommend that you use the transport case (accessory) that was specially designed for the TAPIR HL 1102 A (see 10).



- Remove the foam from the case (1).
- Put the TAPIR HL 1102 A all the way in (2).
- Store the accessories in the foam (optional) (3).
- Replace the foam (4).

#### 3.3.2 Handling

We recommend that you use the transport cart (accessory) that was specially designed for the TAPIR HL 1102 A (see 10).



1 | Fixing screws delivered with the cart

**CAUTION**

**Maximum authorised weight on the transport cart: 26 kg**

→ You must attach the cart to the leak detector.

## 4 Product description

### 4.1 Product identification

To correctly identify the product when communicating with Busch, always have the information from the rating plate available.

**Fig. 1: Nameplate example**

1	Manufacturer
2	Date of manufacture
3	Product name
4	Part number
5	Serial number
6	Weight
7	Maximum power consumption
8	Power supply
9	Barcode

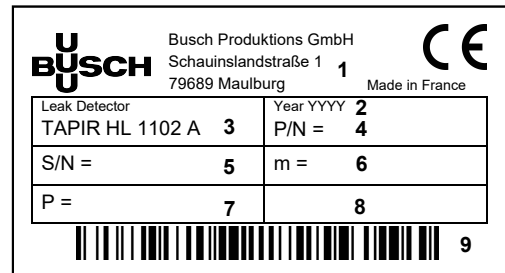







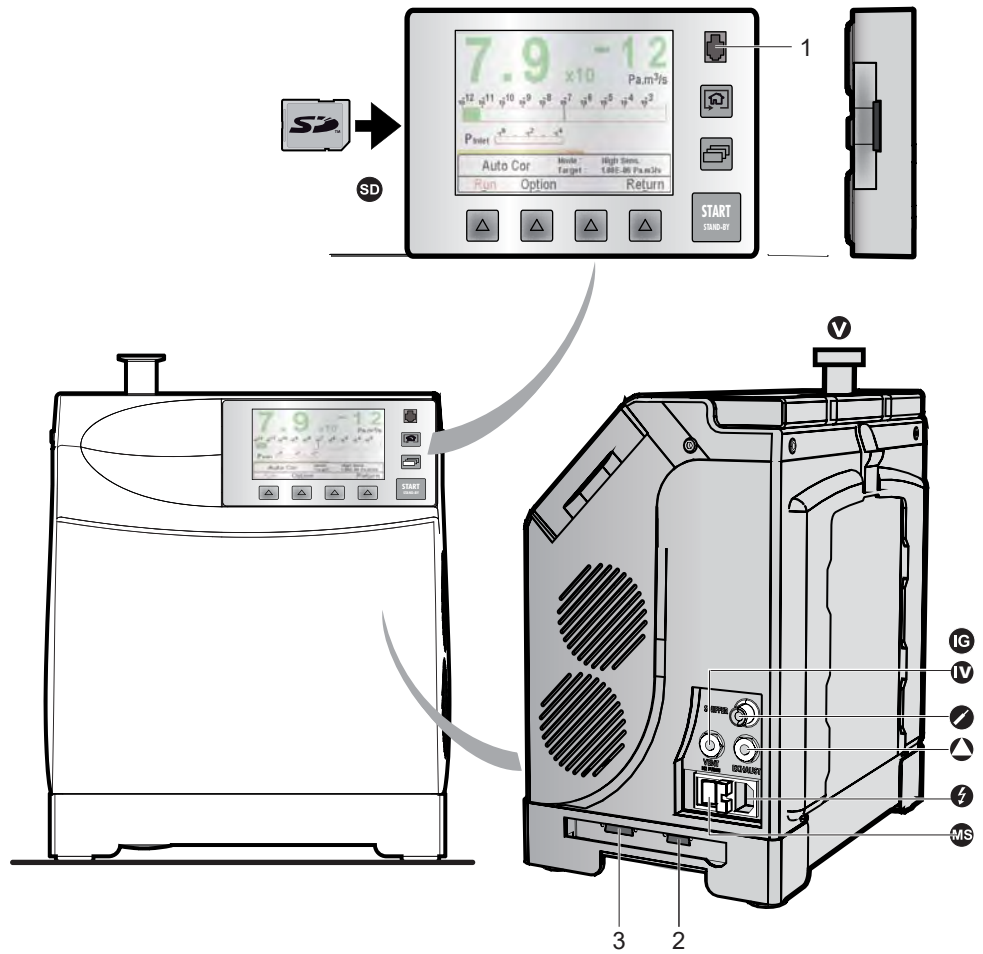

### 4.2 Scope of delivery

- 1 leak detector
- 1 documentation set (operating instructions for the detector and the RS-232)
- 1 power cable for Europe (France/Germany) and/or 1 power cable for US
- 1 calibration certificate for the internal calibrated leak
- 1 SD card in the control panel
- 1 15-pin D-sub plug not wired for I/Os.

### 4.3 Interface connection



**Fig. 2: Human-machine interface**

	Mains power supply		SD card
	Detector inlet (Inlet port)		Sniffer probe connection <sup>(1)</sup> <b>(STANDARD SNIFFER)</b>
	Primary pump Exhaust ( <b>EXHAUST</b> )	<b>1</b>	Not used
	Switch/Circuit breaker	<b>2</b>	RS 232 connector D-Sub 9 pins <b>(SERIAL)</b>
	Neutral gas inlet (purge) <b>(VENT/PURGE)(Do not obstruct)</b>	<b>3</b>	Interface Connector- I/O D-Sub 15 pins <b>(INPUTS / OUTPUTS)</b>
	Inlet vent		

(1). Accessory (at the customer's expense)



## 5 Installation

### 5.1 Prerequisites for optimising measurement

To optimise pumping and measurement speed:

- Use pipe with a diameter equal to the diameter of the detector's inlet. The pipes should be as short as possible and completely sealed.
- Do not use plastic hoses such as compressed air pipes.
- Check that the connected part/installation is impermeable to tracer gas.
- Test only clean, dry parts/installations with no trace of water, vapour, paint, detergent or rinsing products.
- Test that the entire line is completely sealed when the detector is attached to the pumping circuit, to ensure that the connections are correct (pump, pipe, valves, etc.).

### 5.2 Operating conditions



#### DANGER

##### Explosion hazard.

For detecting leaks with 'hydrogen' tracer gas, the operator must use hydrogenated nitrogen (mix of 95 % N<sub>2</sub> and 5 % H<sub>2</sub>).



#### NOTICE

##### Risk of pollution from solid substances

When applications generate particles, we recommend protecting the detector's inlet.

→ Install a inlet filter.



#### NOTICE

##### Detector ventilation

If there is insufficient ventilation, overheating could cause damage to the components:

→ Comply with the ambient operating temperature.

→ Do not obstruct the air vents.

→ Leave a gap of 70 mm around the air vents.

Environmental conditions (see 11.2).

### 5.3 Set-up

The leak detector must be installed on a flat, horizontal surface, supported by its feet, with the detector's inlet port on the top.

→ Choose the location for set up according to the dimensions of the detector: chapter **Technical Characteristics** (see 11.2).

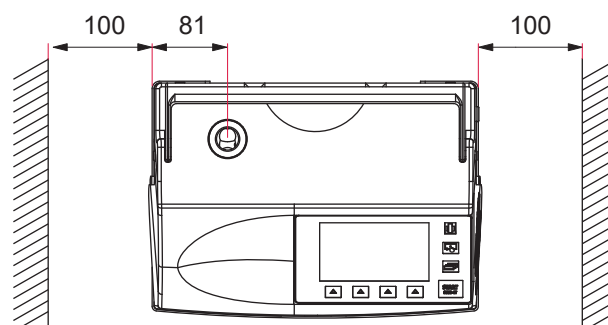

→ Leave 10 cm free for detector ventilation.

### 5.3.1 Use positions

The leak detector can be used horizontally: turn the control panel around for easier reading.

Always check that the product is completely stopped before changing its position. Position the detector in a way that there is no risk of tilting or shock.



### 5.3.2 Control panel fixing

Fixing the control panel means it can be locked for when users should not remove it and possibly separate it from the detector in particular when the detector is being used vertically. This also makes the SD card inaccessible.

The control panel can also be fixed onto any other support thanks to the 2 nuts embedded in the plastic case.

### 5.3.3 Fixture of the cart

(see 3.3.2)

## 5.4 Neutral gas purge and inlet vent connection



#### NOTICE

##### Tracer gas concentration

When the air purge is used, we recommend performing the leak detection in a ventilated room.



#### WARNING

##### Pressurised circuit

To work safely on the product, the operator must:

→ Install a manual valve on the nitrogen circuit at a distance of 3 m from the product, so that the nitrogen supply can be locked.

- In addition to the neutral gas purge, use the "Pollution" function (see 7.3.2).
- Using a neutral gas with a low concentration of tracer gas suppresses the leak detector's background.

**Flow** To guarantee best performance, the nitrogen supply must be clean and filtered, with the following characteristics:

- relative excess pressure: 200 hPa
- flow rate: 5 sccm (if pressure= 1 bar (absolute) at the inlet).

**Usage pressure**

- 0 to 0.3 bar relative (≈ 1.5 to 4.5 psig),
- 1.1 to 1.3 bar absolute (≈ 16 to 20 psia)

- If the purge gas pressure is too high, the inlet valve could always be stay closed.**
- Purge connection** → Attach the nitrogen pipe to the connector **Ⓔ** (see 4.3).
- If no purge system is connected, the gas purge is connected to the ambient air and maintains air flow inside the leak detector.
  - The status of the neutral gas purge (open or closed) depends on the firmware. No settings can be changed by the operator.
- Inlet vent connection** → Attach the nitrogen pipe to the connector **Ⓜ** (see 4.3).
- If no inlet vent system is connected, the inlet vent is connected to the ambient air.
  - The status of the air inlet (open or closed) depends on the parameters set by the operator (see 7.4.5).

## 5.5 Connection to the mains power supply



### WARNING

#### Risk of electromagnetic disturbance

The product's EMC behavior is guaranteed only if the relevant EMC standards are followed during installation.

→ Use shielded cables and connections for the interfaces in interference-prone environments.



### WARNING

#### Hazard associated with non-compliant electrical installation

Safe operation after installation is the operator's responsibility.

→ Connect the product to an installation that is compliant with local safety standards.

→ Do not carry out any alterations or modifications to the product on your own initiative.

→ For specific questions, contact your service center.



The leak detector is Class 1 equipment and therefore must be earthed.

## 5.6 Operating for the first time

- Attach the electrical network to the connector **Ⓕ** using the power cable.
- Set the circuit breaker **ⓂⓈ** to I.
- Set the language, unit, time and date (the operator can modify this at a later time (see 7.7.1)).
- Wait for the detector to enter Stand-by mode.



### 5.6.1 Familiarise yourself with the control panel

Control panel description (see 6.1.1).

- Press  several times to familiarise yourself with the application screens.
- Press  several times to see the 2 levels of function keys available.
- For each level, press  or the control panel function key to access the function.

### 5.6.2 Become familiar with the detector

You can carry out a hard vacuum test and learn about your detector simply by performing a test on the equipment itself.

- Leave the blanked-off flange included with the product in place on the detector's inlet.
- Start a test by pressing . The measured leak rate is displayed: this is the detector's background.
- Stop the test by pressing .

→ To remove the blanked-off flange from the detector's inlet, press **[Inlet vent]**.

## 5.7 Connecting the part/installation to be tested



### NOTICE

#### Limit of operation

→ Make sure that the parts or chambers connected to the inlet of our products withstand a negative pressure of  $1 \cdot 10^3$  hPa in relation to atmospheric pressure.

- The inlet pressure must be no higher than atmospheric pressure. Pressure that is too high can damage the product.
  - The detector's performance depends on the type of accessories used and on the quality of the mechanical connections.
  - When assembling the vacuum circuit, use accessories to shut off the product and make maintenance easier (inlet shut off valves, purge systems, etc.).
  - Comply with these recommendations (see 5.1) to optimise measurement.
  - The maximum permitted weight at the detector's inlet must be no more than 5 kg and the maximum torque must be 3 N·m.
- Remove the blanked-off flange that covers the detector's inlet and save it for reuse during storage or transport.
- Connect the part or the equipment using the connection accessories available in the product catalogue.
- Test that the entire line is completely sealed when the detector is attached to the pumping circuit, to ensure that the connections are correct (pump, pipe, valves, etc.).

## 5.8 Connecting the exhaust



### NOTICE

#### Limit of operation

→ Make sure the exhaust pressure does not exceed 200 hPa (relative). Pressure that is too high can damage the product.

# 6 Operation

## 6.1 Control panel

It is interfaced with the detector and is used to:

- display information about the test
- access the available functions
- setting of the detector's parameters.



**For a screenshot, set a function key to [Screen Copy] (see 7.7.2).**

**If the screen is out of order, functions remain accessible: use RS-232 to pilot/set the detector.**

### 6.1.1 Description

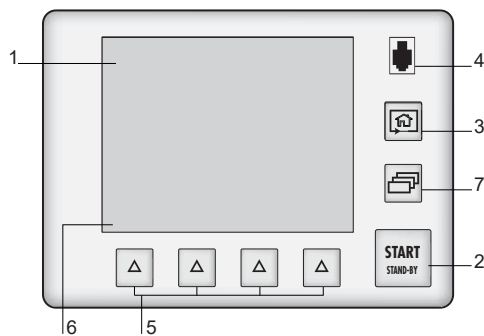

**Fig. 3: Control panel**

1	Application screens (touch screen): these are accessible or hidden see 7.7.3).
2	Test Start/Stop.
3	Changing the application screens: return to the home page (standard screen) from any menu.
4	Standard remote control connection (accessory).
5	Accessing the functions for daily use. Functions assigned to a key by the operator (provides access to the functions if there is a problem with the touch screen).
6	Displaying a function key level: starting the function or displaying a sub-menu by touching the screen.
7	Changing the level of function keys.

➔ Remove the film that protects the screen upon delivery.

➔ Use the touch screen manually without using hard objects such as pens, screwdrivers, etc.

	Function deactivated (OFF)
	Function activated (ON)
	Authorized access without password
	Access locked: access with password
	"Grey" key: access settings or function
	"White" key: key not customisable, for information
	"Measurement information" key: to display the measured leak rate
	Arrows for navigating within the menus
	Access to the error/warning window

	Value selected is customisable
	Keys for setting the values
	Moving to the next function/screen/parameter
	Return to the previous display
	Return to the previous display and confirm the changes made
	Return to the previous display without confirming the changes made
	Deleting the selected file

### 6.1.2 Application screens

The content of the screens is given as an example. Depending on the leak detector and parameters, the display may be different.

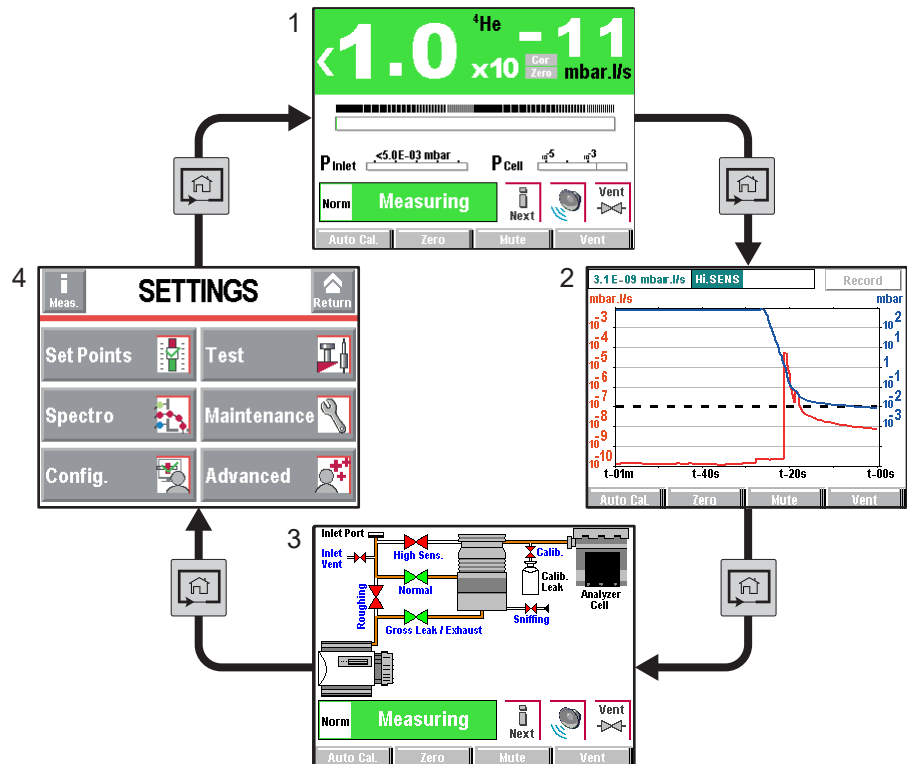

**Fig. 4: Example of each screen**

1	"Standard" screen (home) Information about the current test
2	"Graph" screen Monitoring and recording the leak rate and/or the inlet pressure
3	"Vacuum circuit" screen Vacuum circuit of the detector and the status of the valves
4	"Settings" screen Detector parameters



**The operator can hide and/or switch certain screens in the loop see 7.7.3).**  
For daily use, after the detector's parameters have been set consult primarily the "Standard" screen.

### 6.1.3 "Standard" screen

Information about the test:

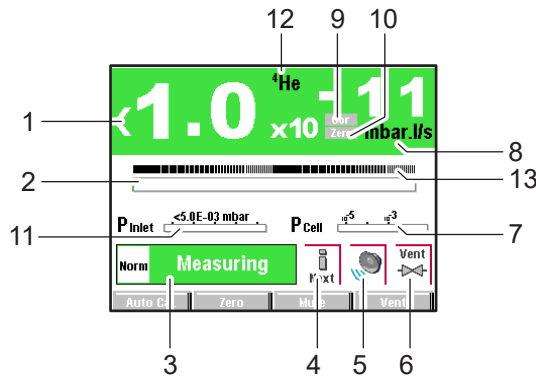

1	Digital display of the leak rate (green $\leq$ reject set point < red)
2	Bargraph display of the leak rate (adjustable scale)
3	Detector status and Detection mode
4	Access error information
5	Mute function indicator
6	Air inlet function indicator
7	Bargraph display of the cell pressure
8	Leak detector unit
9	Leak rate correction function indicator
10	Zero function indicator
11	Bargraph display of the detector inlet pressure (unit consistent with the leak rate unit)
12	Tracer gas ( $^3\text{He}$ , $^4\text{He}$ or $\text{H}_2$ )
13	Bargraph display of Zero function (2 decade)



**A password can be used to lock access to the "Settings" menus while leaving certain functions accessible using the function keys (see 7.7.2).**

### 6.1.4 "Settings" screen

Setting the detector's parameters.

The "Settings" screen is accessible from any window, by pressing the following two keys at the same time + .

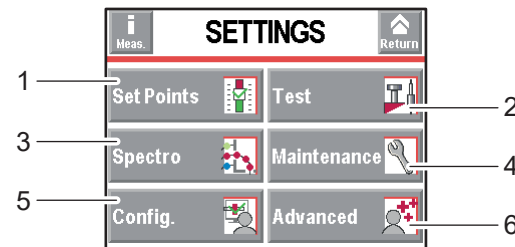

1	Set points setting: reject set point, audio level, digital voice, pollution.
2	Method and test mode selection. Inlet vent management. Correction value. Cycle end.
3	Tracer gas selection. Setting the calibrated leak.
4	Scheduling maintenance
5	Detector setting for the operator: language, unit, password, function keys, application screens.
6	Advanced functions reserved for specific detector uses.



### 6.1.5 "Graph" screen

Monitoring and recording the leak rate and/or the inlet pressure.

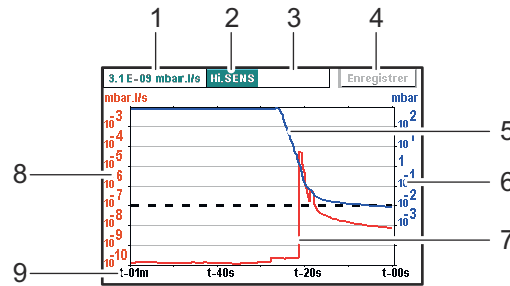

Fig. 5: "Graph" screen

1	Digital leak rate display
2	Detector status and detection mode
3	Indicators of the functions 'Leak rate correction' and 'Zero'
4	Plot recording
5	Inlet pressure plot (in blue)
6	Inlet pressure scale (in blue)
7	Plot of the tracer gas leak rate (in red)
8	Scale of the tracer gas leak rate (in red)
9	Time scale

Scales (6), (8), (9) are adjustable by pressing the graph.

### 6.1.6 "Vacuum circuit" screen

Vacuum circuit of the detector and the status of the valves.

Vacuum circuit is customized for each leak detector.

The vacuum circuit varies depending on the status of the valves, but does not make it possible to manage the valves.

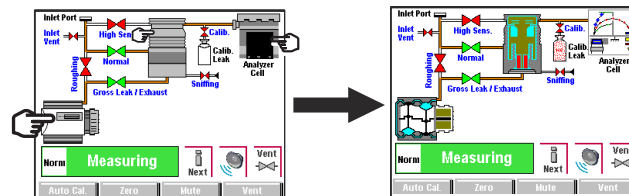

Fig. 6: Example

Red valve	Valve closed
Green valve	Valve open
Pumps, Analyzer cell	⇒ Press the component to display the operating principle.

### 6.1.7 "Measurement" window

→ Press the [Measure] key to display the window.

→ Press and drag the window to move it on the screen.

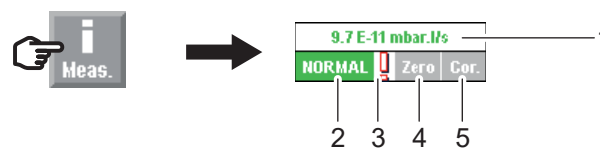

Fig. 7: [Measure] key and corresponding window

1	Digital display of the leak rate (green ≤ reject set point < red)
2	Detector test mode
3	Error information indicator
4	Zero function indicator
5	Leak rate correction function indicator

### 6.1.8 Function keys

The function keys are used to activate/stop a function or to set set points (see 7.7.2).



**Thanks to the function keys, it is possible to give the operator access to a limited number of functions and to use a password to lock unauthorised functions on the "Settings" menu. they are sufficient to manage the detector.**

- To allow the operator to use only the **[Start/Stand-By]** key, do not allocate a function to the function keys and lock the "Settings" menu.
- Up to 4 additional function keys can be added, for a maximum of 12. In this case, a 3<sup>rd</sup> level is made available to the operator.

## 6.2 Prerequisites to use

The leak detector is set to perform a hard vacuum test in the normal test mode according to the initial settings (see 7.2).

For use with any other parameters or other functions, see **Chapter 7**.



**NOTICE**

**Risk of seizing**

- Never move the detector while it is in use, even if it is placed on a trolley.

Before each switching on:

- Become familiar with the safety instructions (see 2).
- Check that all the connections are correct (see 5).
- Before use, make sure that the leak detector is in an environment free of tracer gas.
- Check that the electrical network is properly attached to the connector ⚡ using the power cable.

## 6.3 Switching the detector on

- Set the circuit breaker **MS** to **I** (see 4.3).

The various stages for switching the detector on are displayed. The detector is ready for testing when the Stand-by screen appears.

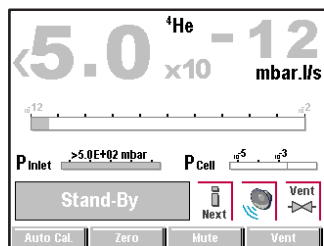

**Fig. 8: Stand-by screen**

#### Switching the detector on for the first time

(see 5.6)

#### Switching on after an extended shutdown

If the detector has been stored or has not been used, switching on time will be longer than if it is in regular use.

## 6.4 Starting a test

There are 2 possible test methods:

- Hard vacuum test method
- Sniffing test method

### 6.4.1 Hard vacuum test method

Part that can be connected to pipe and placed under a vacuum.

Part that can be placed in a vacuum chamber.

This method involves removing the air from the part to be tested, connecting it to the detector's analyzer cell, then spraying tracer gas on the points of the part that are likely to leak.

The detector measures the flow of tracer gas that penetrates due to part leakage.

When spraying starts, the leak rate is not displayed instantaneously: there is a response time which depends on the volume V being tested and the tracer gas pumping speed S of the system at the opening of the part, according to the following relation:

$T = V/S$  (where T = seconds, V = litres, S = l/s).

T is the time required for the leak rate to reach 63 % of the final value.

- Procedure**
- Select the 'hard vacuum' test method (see 7.4.1).
  - Set the test mode (see 7.4.3).
  - Set the reject set point if necessary (see 7.3.3).
  - Set the detector to Stand-by mode.
  - Prepare the part to be tested.
    - Remove the air from the part to be tested
    - Connect the part to be tested to the leak detector inlet port.
  - Start a test by pressing 
    - Spray tracer gas on the points of the part that are likely to leak.

The various test stages are displayed.
  - When the detector has reached the most sensitive test mode, wait for the measurement to stabilise: the measurement displayed corresponds to the measured leak rate.
  - Stop the test by pressing 

### 6.4.2 Sniffing test method



Part that can be connected to pipe and cannot be placed under a vacuum.

The part to be tested is pressurised with tracer gas.

The detector measures the flow of tracer gas that leaks out of the part through a sniffer probe that moves across all the points prone to leaking.

The detector measures the flow of tracer gas that leaks out of the part.

The measured leak rate is not an exact measurement of the leak. The sniffer probe only detects part of the tracer gas escaping from the part, depending on the distance separating the crack from the tip of the probe, and the direction of the leak in relation to the probe.

- Procedure**
- ➔ Set the reject set point **if necessary** (see 7.3.4) .
  - ➔ With the leak detector in Stand-by mode, connect the sniffer probe (accessory) to the provided connector (🔌).
  - ➔ Start a test by pressing  .
  - ➔ Slowly scan, with the sniffer probe, the areas of the part to be tested with potential leak: the displayed leak rate varies in presence of a detected leak (qualitative value of the measured leak rate).
  - ➔ Stop the test by pressing  .

## 6.5 Calibration

Calibration helps ensure that the leak detector is correctly adjusted to detect the tracer gas selected and display the correct leak rate. A calibrated leak is used to calibrate the leak detector.

Depending on the test method, different types of calibration can be performed.

	Test method	
	Hard Vacuum	Sniffing
With the internal calibrated leak	yes	yes (*)
With an external calibrated leak	yes	no
With the ambient air (ambient air not contaminated by the tracer gas)	no	no

(\*) in this case, the flow of the sniffer probe is not included in the leak detector calibration process.

### 6.5.1 Calibration with the internal calibrated leak

The internal calibrated leak is specifically designed for the leak detector. It is composed of:

- a Helium 4 reservoir (no internal calibration with the other tracer gases),
- a temperature sensor (to take into account the effect of temperature on the leak rate),
- an integrated diaphragm (to calibrate the leak rate),
- an identification label (identical to the identification label of an external calibrated leak).

The calibrated leak is supplied with a calibration certificate.

Use a calibrated leak in the range  $\approx 10^{-8}$  Pa.m<sup>3</sup>/s ( $\approx 10^{-7}$  mbar.l/s).

**Procedure** When switching the leak detector on, calibration with the internal calibrated leak is automatically initiated if the calibration parameter is set on 'Start-up' and if the type of calibrated leak is set on 'Internal'.

The calibration can be launched when the detector is :

- in test mode for leak test
  - in test or in Stand-by mode for sniffing test.
- ➔ Check the leak settings (corrected leak rate to take temperature and time into account if necessary) (see 7.5.3).
  - ➔ Press **[Auto cal]** key to launch a calibration.

In the case of intensive use of the detector, a spare internal calibrated leak is recommended. If this is not possible, the detector can still be used and calibrated using an external calibrated leak.



### NOTICE

#### Detector calibration

When switched on, the detector suggests that the operator carry out an auto-calibration (if calibration parameter = 'operator'). For the optimal use of the detector, **this auto-calibration must be performed**. In all situations, a calibration must be performed:

- at least once a day
- to optimise the measurement reliability for high sensitivity tests
- if it is uncertain whether the detector is working properly
- during intense and continuous operation: start an internal calibration at the beginning of each work session (e.g. work in teams, every 8 hours).

## 6.5.2 Calibration with an external calibrated leak

The operator must use a calibrated leak containing the tracer gas selected ( $^4\text{He}$ ,  $^3\text{He}$  or  $\text{H}_2$ ). There are several types of external calibrated leaks, with or without reservoir, with or without valve, covering several leak ranges. Use calibrated leaks from the ranges indicated below.

Gas	Minimum Value	Maximum Value
$^4\text{He}$	$\approx 1.10^{-9}$ mbar·l/s $\approx 1.10^{-10}$ Pa·m <sup>3</sup> /s	$1.10^{-4}$ mbar·l/s $1.10^{-5}$ Pa·m <sup>3</sup> /s
$^3\text{He}$	$\approx 3.10^{-7}$ mbar·l/s $\approx 3.10^{-8}$ Pa·m <sup>3</sup> /s	$1.10^{-4}$ mbar·l/s $1.10^{-5}$ Pa·m <sup>3</sup> /s
$\text{H}_2$	$\approx 5.10^{-6}$ mbar·l/s $\approx 5.10^{-7}$ Pa·m <sup>3</sup> /s	$1.10^{-4}$ mbar·l/s $1.10^{-5}$ Pa·m <sup>3</sup> /s



**The choice of external calibrated leak depends on the needs of the application: use a calibrated leak from the same leak rate range as the leak to be measured.**

The manufacturer does not provide calibrated leaks in  $^3\text{He}$  and  $\text{H}_2$ .

## 6.5.3 Calibration procedure with external leak in Hard Vacuum test

- Allocate a function key to **[Auto.Cal]** (see 7.7.2).
- Configure the following settings:
  - test method = hard Vacuum (see 7.4.1)
  - type of calibrated leak = external (see 7.5.3)
  - calibration = operator (see 7.8.5)
- Check the settings and value of the external calibrated leak used (see 7.5.3).  
Correct the temperature, month and year if necessary.
- Select the tracer gas of the external calibrated leak (see 7.5.3).
- Place the external calibrated leak on the detector inlet port.
- Verify that the detector is on Stand-by mode.
- Press the **[Auto.Cal]** function key to start the calibration.
- Follow the instructions provided by the leak detector: press **[Next]** to move to the next stage.

At the end of the calibration, the detector returns to Stand-by mode.



**Recommended procedure when the measuring range differs from the value of the internal calibrated leak.**

### 6.5.4 Calibration with a pumping system in parallel

When the leak detector is connected to an installation equipped with its own pumping system, only part of the leak will be measured by the leak detector. Calibration gives a direct reading of the leak rate by taking into account the loss of tracer gas of the leak pumped by the pumping unit. Calibration is performed via the Correction function.

**Target value** 2 possible target values:

Target value =	Hard Vacuum	Sniffing
External calibrated leak value <sup>(1)</sup>	yes	no
Known tracer gas concentration	yes	no

(1) When an external calibrated leak is used, it is recommended to take into account the calibration date and temperature effect for calculating the target value from the calibrated leak value featured on its identification label.

- Corrected leak rate = target value = measured leak value x correction factor.

**Procedure** Correction must be performed when the leak detector is already calibrated with its internal calibrated leak.

- ➔ Allocate a **[Correction]** function key (see 7.7.2)
- ➔ Select the 'hard vacuum' test mode.

➔ Press  to start a test.

➔ Press the **[Correction]** function key.

- if the value of the correction factor to be applied is known:
  - Press **[Value]** and configure the correction factor to be applied. The correction factor is the coefficient to be applied to the measured leak rate.
  - Press **[Return]** to exit the function.
- if the value of the target leak rate is known (value of the external calibrated leak or concentration):
  - Press **[AutoCal] [Target]** and configure the target leak rate.
  - Press **[Start]** to make the correction.
  - Press **[Return]** to exit the function.

➔ Press **[RAZ]** to reset the correction factor to 1.

The '**COR**' indicator light (see 6.1.3, Rep 9) is illuminated on the control panel as soon as the value of the correction factor is not 1. The digital display takes into account the correction factor applied.

The bargraph display does not take into account the correction factor applied.

## 6.6 Monitoring operation

When the detector is in use, the operator is alerted to incidents as follows:

- Pictogram display indicating that the error message should be read.
- Error display on the screen.

## 6.7 Shutdown the detector



Vacuum the leak detector by pressing the cycle button, then leave it for 2 min in the cycle before turning it off.

- Set the circuit breaker **MS** to **O** (see 4.3).
- After the control panel screen has completely extinguished, wait 2 minutes before working on the product, removing the covers and/or moving it.

### Shutdown due to a mains power failure

When there is a mains power failure, the detector shuts down: it switches on again automatically when power is restored.

## 6.8 Saving and downloading the product's configuration

When a detector is installed or replaced, it is helpful to copy the configuration (all the parameters and operating set points programmed by the operator) of a detector that is the same model.

- Do this while the detector is switched on and in Stand-by mode.

### 6.8.1 Saving the configuration

- Follow the procedure for saving (see 7.8.11).

The detector's configuration will be saved on the SD card from control panel.

### 6.8.2 Downloading the configuration

- Follow the procedure for downloading (see 7.8.11).

The previous configuration is automatically updated.

All the detector's parameters are downloaded except the following, which must be set by the operator:

- language
- time and date
- temperature unit
- pressure unit
- serial link.

# 7 Advanced settings

## 7.1 "Graph" screen

→ Access the "Graph" screen by pressing .

### 7.1.1 Description

Monitoring and recording the leak rate and/or the inlet pressure.

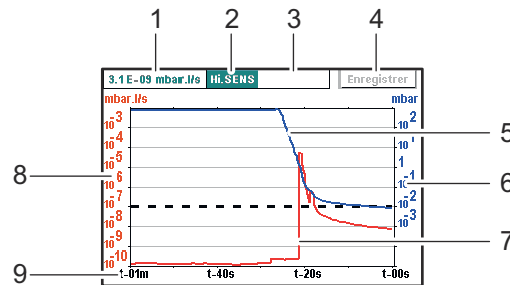

Fig. 9: "Graph" screen

1	Digital leak rate display
2	Detector status and detection mode
3	Indicators of the functions 'Leak rate correction' and 'Zero'
4	Plot recording
5	Inlet pressure plot (in blue)
6	Inlet pressure scale (in blue)
7	Plot of the tracer gas leak rate (in red)
8	Scale of the tracer gas leak rate (in red)
9	Time scale

Scales (6), (8), (9) are adjustable by pressing the graph.

### 7.1.2 Settings

→ Access the graph settings menu by pressing the graph.

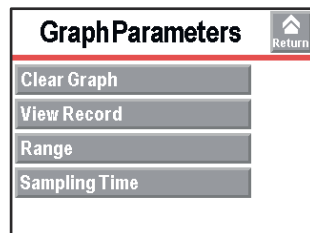

### 7.1.3 Scales setting

→ Press on the graph and on **[Scale]** to change the graph parameters.

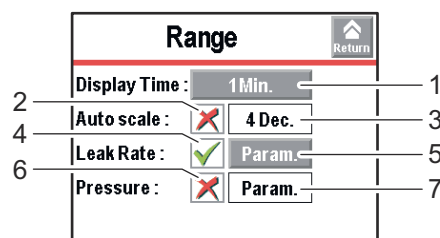

1	Period of time displayed on the screen
2	Activating/Deactivating the automatic scale
3	Setting the automatic scale



4	Displaying/Hiding the measured leak rate
5	Setting the leak rate scale (If 'automatic' scale is deactivated)
6	Displaying/Hiding the inlet pressure
7	Setting the inlet pressure scale

**Automatic scale**

The automatic scale is used to display the measured leak rate centred on 2 or 4 decades. The scale varies according to the leak rate measured. When the automatic scale is activated, the scales set for the leak rate and pressure are no longer taken into account.

Example: leak rate =  $5 \cdot 10^{-7}$  mbar·l/s ( $5 \cdot 10^{-8}$  Pa·m<sup>3</sup>/s )

- automatic scale 2 decades: scale from  $1 \cdot 10^{-6}$  to  $1 \cdot 10^{-8}$  mbar·l/s ( $1 \cdot 10^{-7}$  to  $1 \cdot 10^{-9}$  Pa·m<sup>3</sup>/s )
- automatic scale 4 decades: scale from  $1 \cdot 10^{-5}$  to  $1 \cdot 10^{-9}$  mbar·l/s ( $1 \cdot 10^{-6}$  to  $1 \cdot 10^{-10}$  Pa·m<sup>3</sup>/s )

**7.1.4 Graph clearing****Current window**

- Press on the screen and **[Clear Graph]**.
- Validate the message.

Clearing the current window does not delete the current recording or recordings already made.

**Recording**

- Press on the screen and **[View Rec.]**.
- Press **[Clear]**.
- Validate the message.

**7.1.5 Recording**

Recording makes it possible to store the measurements taken during the test in the control panel memory: **it will not save these measurements** (see 7.1.6).

During a recording, all the detector functions are available.

After the detector is switched off (cut off at the mains or by the operator), the recordings already made are stored in the memory. For the next recording, the operator will have to specify:

- if the new recording is to be added to the recordings in the memory **[OK]**
- if the new recording is to delete or replace the recordings in the memory **[Cancel]**.

- Press on the graph and **[Record]** to change recording parameters.
- Press on the graph and **[Scale]** to change graph parameters.
- Press **[Record]** (4) (see 7.1.1) to start recording

None of the measurements displayed on the plot before the recording starts will be recorded.

- Press **[Stop Rec.]** (4) (see 7.1.1) to stop recording.
- Press on the graph and **[View Rec.]** to see the recording.

If the memory is not cleared between two recordings (**[Clear]** ((see 7.1.4)), all subsequent recordings will appear consecutively on the same memorised plot. A ▲ cursor indicates the end of each recording.

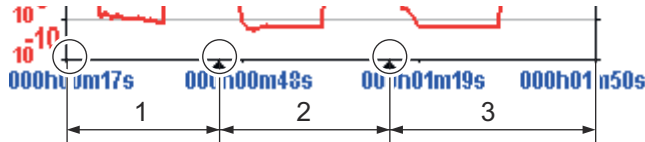
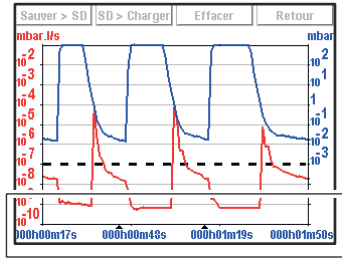

Fig. 10: Recording example

- |   |                           |
|---|---------------------------|
| 1 | 1 <sup>st</sup> recording |
| 2 | 2 <sup>nd</sup> recording |
| 3 | 3 <sup>rd</sup> recording |

When the memory is full and if a recording is in progress, recording is automatically stopped.

The **[Record]** key is replaced by the **[Mem full]**.

**Recording** → Press **[Recording]**.

Duration	Recording duration	
Capacity	Total recording time according to recording duration	
<b>Duration</b>	<b>Maximum capacity</b>	<b>File size</b>
0.2 s (min.)	6 hours 33 minutes	≈ 7 Mo
30 s (max.)	983 hours	

### 7.1.6 Saving a recording

This function is used to save the most recent recording on a SD card to be played back/analysed later on a PC. Saving is not automatic.

It is possible to save a screenshot of the recording (.bmp) or to generate a file (.txt) with all the measurements taken. The .txt file allows a later processing: the default separator is "tab"

- Press on the screen and **[View Rec.]**.
- Select the file type and press **[Save > SD]** (see 7.1.5).
- Name the file and save it

The saved .bmp and .txt files include only the measurement points displayed on the screen:

- to include all points, you must be positioned on the relevant plot (without zooming).
- if a zoom was carried out before saving, the zoom will apply only to the points of the selected zone.

If the saved recording is made up of several consecutive recordings:

- the ▲ cursor will indicate each new recording on the .bmp files.
- "B.P. # xx" will be noted at the end of the last line of each recording in the .txt files.

.bmp files can be displayed on the control panel screen.

.txt files can be opened only from a PC: no possible reading from the control panel.

### 7.1.7 Viewing a recording



**At any time, the operator can view the recording already made or zoom in on a recording, without stopping the current recording.**

→ Press on the screen and **[View Rec.]** to view the recording made since the last recording was deleted (1) (see 7.1.1).

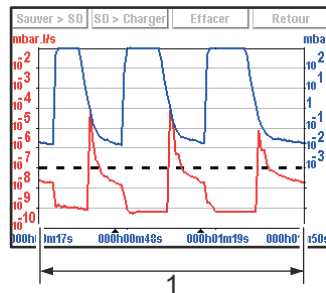

**Fig. 11: Viewing a recording**

1 | Total recording time

If no plots have been made, the message "Memory empty" is displayed.

**Zoom in** Zoom in available only for a recording.

→ Press on the graph and **[View Rec.]** (see 7.1.1).

→ Set the area to be enlarged ((1) then (2)).

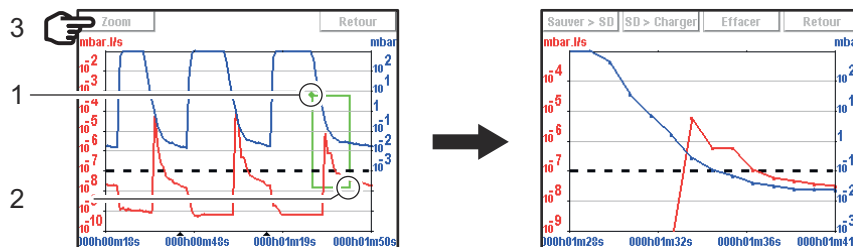

**Fig. 12: Selection and viewing the area to be enlarged**

→ Press **[Zoom]** (3): the enlarged area is displayed.

Several successive zooms are possible (except in the same decade).



**If necessary, adjust the area to be enlarged by dragging the corners or sides with your finger.**

**Zoom out** Zoom out available only for a recording.

→ Press on 2 occasions on the zoom ((1) then (2)) to return to the original graph.

– The point (2) always has to be situated before the point (1): see example below.

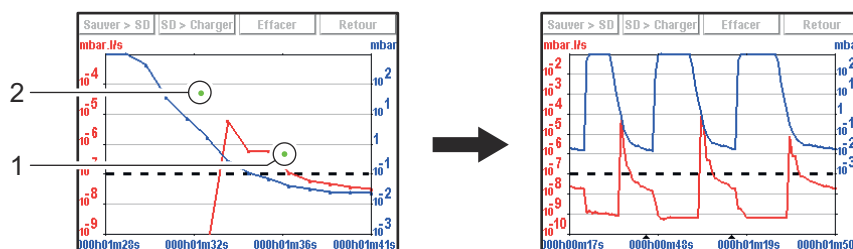
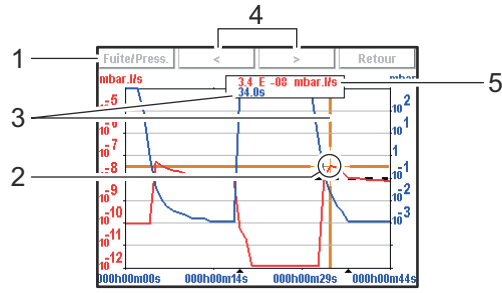

**Fig. 13: Return to the original graph**

**Measurement** Exact measurement of a point only available on a recording.

→ Select the point to measure (2).

→ Press **[Measure]**: the exact measurement of the selected point is displayed.



**Fig. 14: Exact measurement of the selected point**

- |   |  |
|---|--|
| 1 | Selecting the display of the leak rate or the inlet pressure                 |
| 2 | Marker indicating the selected point   |
| 3 | Moment the measurement took place in relation to the start of the recording  |
| 4 | Navigation between next/previous recorded points                             |
| 5 | Displaying the tracer gas leak rate (in red) or the inlet pressure (in blue) |



**To make the exact values of all measurements available on any type of spreadsheet, save the recording to a .txt file.**

## 7.2 Tree diagram of the "Settings" menu

The following table shows the detector's initial settings. When the detector is off, all the memorised values and parameters are saved for the next use.

The operator can save and download different leak detector configurations (see 7.8.11).



The saved values are the values set at the time saving takes place.

### Set point setting

1	x10	→	1.0 x10 <sup>-07</sup>
2	x1	→	1.0 x10 <sup>-07</sup>
3	x0.1	→	1.0 x10 <sup>-07</sup>

1	Exponent setting
2	Mantissa unit setting
3	Mantissa tenth setting

### 7.2.1 Tree diagram of the "Set points" menu

SET POINTS			
Selection		Choice - Setting limit	Initial settings
Audio	Status	Deactivated / Activated	Activated
	Setting (If Activated)	1 - 9	3
Digital voice	Status	Deactivated) / Activated)	Activated
	Setting (If Activated)	1 - 9	4
Pollution	Status	Deactivated / Activated	Deactivated
	Setting (If Activated)	1·10 <sup>+19</sup> - 1·10 <sup>-19</sup>	1·10 <sup>-05</sup>
Hard Vacuum Set Points	Reject point	1·10 <sup>+06</sup> - 1·10 <sup>-13</sup>	1·10 <sup>-08</sup>
Sniffer set Points	Reject point	1·10 <sup>+06</sup> - 1·10 <sup>-12</sup>	1·10 <sup>-04</sup>
	Probe clogged	1·10 <sup>+19</sup> - 1·10 <sup>-19</sup>	1·10 <sup>-06</sup>

### 7.2.2 Tree diagram of the "Test" menu

<b>TEST</b>						
<b>Selection</b>				<b>Choice - Setting limit</b>	<b>Initial settings</b>	
Method				Hard Vacuum / Sniffer	Hard Vacuum	
HV or sniffing correction	Status			Deactivated / Activated	Deactivated	
	Setting (If Activated)			$1 \cdot 10^{+20}$ - $1 \cdot 10^{-20}$	$1 \cdot 10^{+0}$	
Mode	(If hard vacuum test method)			Gross Leak / Normal / High Sensitivity	High Sensitivity	
Type of probe	(If sniffer test method)			Standard	Standard	
Automatic cycle end	Automatic cycle end			Operator / Automatic	Operator	
	Value  (If Activated)	Evacuation delay	Status	Deactivated / Activated	Activated	
			Value	0 - 1 h	10 s	
Test Timer			0 - 1 h	10 s		
Inlet vent	Inlet vent			Operator / Automatic	Operator	
	Delay			0 - 2 s	0 s	
	Vent Timer	Status		Deactivated / Activated	Deactivated	
		Setting (If Activated)		0 - 1 h	9 s	
Memo function	Active			No / Yes	No	
	Display Time	Status		Deactivated / Activated	Deactivated	
		Setting (If Activated)		0 - 1 h	10 s	
Zero activation	Activation			Operator / Automatic	Operator	
	Value  (If automatic)	Trigger		Timer / Set point	Timer	
		Value	If Timer		0 - 1 h	10 s
			If Set Point		$1 \cdot 10^{+19}$ - $1 \cdot 10^{-19}$	$5 \cdot 10^{-7}$

### 7.2.3 Tree diagram of the "Spectro" menu

<b>SPECTRO</b>				
<b>Selection</b>			<b>Choice - setting limit</b>	<b>Initial settings</b>
Tracer Gas			Helium 4 / Helium 3 / Hydrogen	Helium 4
Filament selected			1 / 2	1
Filament			Off / On	On

SPECTRO				
Selection		Choice - setting limit	Initial settings	
Filament Status		0 - 100 %	100 %	
Calibrated Leak	Tracer Gas		Helium 4 / Helium 3 / Hydrogen	
	Type		Internal / External	
	Unit		mbar·l/s / Pa·m <sup>3</sup> /s / Torr·l/s / atm.cc/s / ppm	
	Leak Value		-	Refer to certificate delivered with the detector
	Calibration valve		Closed / open	Closed
	Loss Per Year (%)		0 - 99	6
	Reference Temperature (°C)		0 - 99	23
	Temperature Coefficient (%/°c)		0.0 - 9.9	3.0
	Year		-	Refer to certificate delivered with the detector
	Internal Temperature (°C) (If type = internal) External Temperature (°C) (If type = external)		-	-

#### 7.2.4 Tree diagram of the "Maintenance" menu

MAINTENANCE					
Selection		Choice - Setting limit	Initial settings		
Detector		-	20		
Timers	Detector		-	20	
	Filament 1	Timer		-	20
		Reset Timer	Function launching	-	-
	Filament 2	Timer		-	0
		Reset Timer	Function launching	-	-
	Calibrated leak		-	To set	
	Cycle Counter	%		-	0
		Time interval		1·10 <sup>+19</sup> - 1	5·10 <sup>5</sup>
		Reset counter	Function launching	-	-
	Primary Pump	%		-	20
		Time interval (h)		0 - 99999	15000
		Reset Timer	Function launching	-	-
	Secondary Pump 1	Timer (h)		-	20
		Time interval (h)		-	15000
Reset Timer		Function launching	-	-	
Speed (rpm)		-	-		
Detector Information	Access to general information		-	-	
Pump Information	Primary Pump 1	Used		-	Yes
		Status		-	On
		Speed		-	Maxi
		Synchro		-	Yes
	Secondary Pump 1	Status		-	On
		Rotation		-	Synchro
		Speed (rpm)		-	42000
Events History		-	Empty		
Calibration History		-	Empty		

### 7.2.5 Tree diagram of the "Configuration" menu

CONFIGURATION					
Selection		Choice - Setting limit	Initial settings		
Unit/Date/Time/Language	Unit	mbar·l/s / Pa·m <sup>3</sup> /s / Torr·l/s / atm·cc/s / ppm	To set		
	Date	mm/dd/yyyy	To set		
	Time	hh:mm:ss	To set		
	Language	English / French / German / Italian / Chinese / Japanese / Korean / Spanish / Russian	To set		
Function keys	Configuration	-	-		
Application Windows	"Standard" Window Parameters	Bargraph display of the leak rate	Zoom on Set Point	No / Yes	No
			Low Decade	1·10 <sup>+5</sup> - 1·10 <sup>-13</sup>	1·10 <sup>-12</sup>
			High Decade	1·10 <sup>+0</sup> - 1·10 <sup>-12</sup>	1·10 <sup>-2</sup>
		Stand-By value	Deactivated / Activated	Activated	
		Inlet Pressure	Deactivated / Activated	Activated	
		Cell pressure	Deactivated / Activated	Deactivated	
		Lower Disp. Limit	1·10 <sup>+19</sup> - 1·10 <sup>-19</sup>	1·10 <sup>-13</sup>	
	Standard	Access	-	Show	
		Order	-	1 <sup>st</sup>	
	Graph	Access	Deactivated / Activated	Activated	
		Order (If Show)	2 <sup>nd</sup> - 4 <sup>th</sup>	2 <sup>th</sup>	
	Vacuum Circuit	Access	Deactivated / Activated	Activated	
		Order (If Show)	2 <sup>nd</sup> - 4 <sup>th</sup>	3 <sup>th</sup>	
Settings	Access	Deactivated / Activated	Activated		
	Order (If Show)	2 <sup>nd</sup> - 4 <sup>th</sup>	4 <sup>th</sup>		
Screen Settings	Brightness		High / Low	High	
	Contrast		0 - 100	50	
	Panel off		None / 15 min / 30 min / 1 h / 2 h / 4 hours	None	
	Paging Function	Without wireless remote control detected	-	None	
		With wireless remote control detected	Off / On	Off	
	Reset panel parameters	Function launching	-	-	



CONFIGURATION			
Selection		Choice - Setting limit	Initial settings
Access / Password	Password	0000 - 9999	5555
	Set Points Menu Access	Lock / Unlock	Unlock
	Test Menu Access	Lock / Unlock	Unlock
	Spectro Menu Access	Lock / Unlock	Unlock
	Maintenance Menu Access	Lock / Unlock	Unlock
	Configuration Menu Access	Lock / Unlock	Unlock
	Advanced Menu Access	Lock / Unlock	Unlock
	User Level	Restricted Access / Medium Access / Full Access	Full Access
	Change Password	0000 - 9999	

## 7.2.6 Tree diagram of the "Advanced" menu

ADVANCED						
Selection		Choice - Setting limit	Initial settings			
Leak Detection	Start-up timer	0 - 1 h	10 s			
	Background Suppression	Activation	Off / On	On		
		Calibration	Calibration	Operator / Start-Up / Manual	Start-Up	
	Calibration checking	Checking	Operator / Automatic	Operator		
			Frequency (If automatic)	Cycle Counter	0 - 9999	50
			Hours	0 - 9999	10	
	Analyzer Cell	Filament Selected	1 / 2	1		
		Filament	Off / On	On		
		Triode pressure	-	-		
		Electric Zero	-	-		
Calibration valve		-	Closed			
Target value		-	-			
Acceleration Voltage (V)		-	-			
Emission (mA)		-	-			
Sensitivity Coefficient		-	-			
Internal Temperature (°C)	-	-				
Internal Pirani Calibration	Function launching	-	-			

<b>ADVANCED</b>							
<b>Selection</b>				<b>Choice - Setting limit</b>	<b>Initial settings</b>		
Input/Output	Serial Link 1	Type		Serial	Serial		
		Parameters	Mode		Basic / Spreadsheet / Advanced / Data export /	Advanced	
			Handshake		None / XON / XOFF		None
			Power Pin 9		-		5 V
	Serial Link 2	Type		Not used	Not used		
	I/O connector	Analog Output	9-gnd	Allocation	See <i>Manual I/O 15 pins</i>	Mantissa	
				Value	According to allocation	-	
			10-gnd	Allocation	See <i>Manual I/O 15 pins</i>	Logarithmic	
				Value	According to allocation	10 <sup>-12</sup>	
			12-gnd	Allocation	-	Exponent	
Value				10 <sup>+2</sup> - 10 <sup>-13</sup>	10 <sup>-12</sup>		
Load config from SD card		Function launching		-	-		
SD card		Load LD Parameter	Function launching		-	-	
	Save LD Parameter	Function launching		-	-		
	Visualize *.BMP	Function launching		-	-		
Service	Access to the Service menu is password protected (Service)			-	-		

## 7.3 Set points Menu

→ From the "Settings" screen, press **[Set points]** to access the menu.

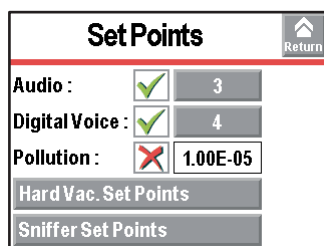

### 7.3.1 Audio alarm and digital voice

**Audio alarm** The audio alarm informs the operator that the reject set point has been crossed. The level varies from 0 to 9 (0 to 90 dB (A)).

**From the "Settings" screen, press [Set points].**

Audio	⇒ Activate the audio level.
	⇒ Set the audio level.



**For quick access from the control panel, set a function key to [Audio] (see 7.7.2).**



Fig. 15: "Audio" screen using a function key

**Digital voice** Digital voice informs the operator about the status of the detector or actions to be carried out. The level varies from 0 to 9

**From the "Settings" screen, press [Set points].**

Digital voice	⇒ Activate digital voice.
	⇒ Set the digital voice level.



**For quick access from the control panel, set a function key for [Voice] (see 7.7.2).**



Fig. 16: "Voice" screen using a function key

**"Mute" function** → Stop the audio alarm and the digital voice at the same time with the **[Mute]**.



**To launch the function from the control panel, set a function key to [Mute] (see 7.7.2).**

### 7.3.2 Pollution function

This is a safety device for the detector. It prevents too much leaked tracer gas from penetrating the detector. We recommend setting the pollution set point to a maximum of 4 decades above the reject set point. If the leak rate rapidly increases above the pollution set point, the cycle stops automatically and the leak detector returns to Stand-by mode.

**From the "Settings" screen, press [Set points].**

Pollution	⇒ Activate the function.
	⇒ Set the application set point.



**Useful function if the part or installation to be tested is likely to have gross leaks.**

### 7.3.3 Hard Vacuum reject point

The hard vacuum reject point defines the acceptance set point for parts that are "accepted/rejected" in a hard vacuum test:

- Measured leak rate  $\leq$  reject set point: part accepted
- Measured leak rate  $>$  reject set point: part rejected

---

From the "Settings" screen, press [Set points] [Hard Vacuum set points].

---

Reject point     $\Rightarrow$  Set the reject point value.

---



**For quick access from the control panel, set a function key for [Reject Point] (see 7.7.2).**



Fig. 17: "Reject point" screen using a function key.

### 7.3.4 Sniffing reject set point

The sniffing reject set point defines the acceptance set point for parts that are "accepted/rejected" in a sniffing test:

- Measured leak rate  $\leq$  reject set point: part accepted
- Measured leak rate  $>$  reject set point: part rejected.

---

From the "Settings" screen, press [Set Points] [Sniffing Set Points].

---

Reject point     $\Rightarrow$  Set the set point value.

---



**For quick access from the control panel, set a function key for [Reject Set Point] (see 7.7.2)**



Fig. 18: "Reject point" screen using a function key.

### 7.3.5 Probe clogged set point

The purpose of this set point is to check that the sniffer probe (accessory) is operational. When the measured leak rate is lower than the set 'Probe clogged' set point, the operator receives a message to check the probe. (see **Sniffer probe operating instructions**).

---

From the "Settings" screen, press [Set Points] [Sniffing Set Points].

---

Probe clogged     $\Rightarrow$  Set the set point value.

---

- Set point unit is the unit set for the detector.
- $\rightarrow$  Block the end of the sniffer probe from time to time with your finger to check that the leak rate is going down. If not, the probe may be clogged. Do not block the end for too long: if the measured leak rate decreases too much, there is risk of exiting the sniffing test.

## 7.4 Test Menu

→ From the "Settings" screen, press [Test].

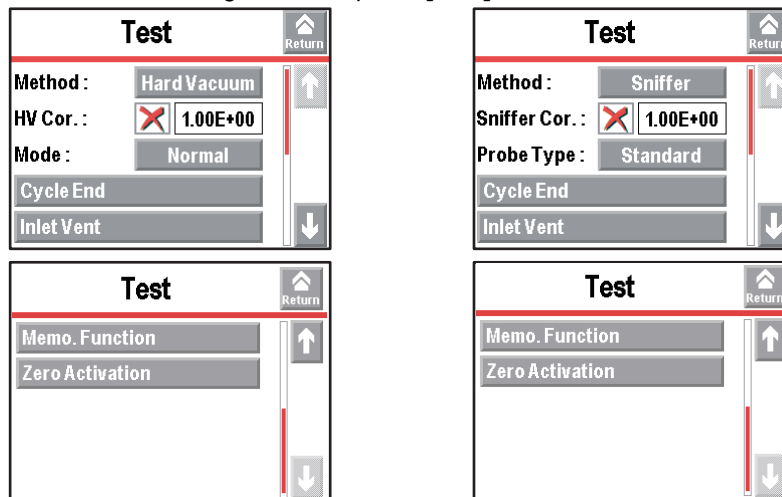

Hard vacuum test method

Sniffing test method

Fig. 19: Menu Test

### 7.4.1 Test method

There are 2 possible test methods:

- hard vacuum test (see 6.4.1),
- sniffing test (see 6.4.2) (sniffer probe required (see 10)).

From the "Settings" screen, press [Test].

Method	⇒ Select the test method. – For the hard vacuum test, set the test mode (see 7.4.3).
--------	---



**NOTICE**

**Limit of operation**

→ Make sure that the parts or chambers connected to the inlet of our products withstand a negative pressure of  $1 \cdot 10^3$  hPa in relation to atmospheric pressure.



For quick access from the control panel, set a function key for [Method] (see 7.7.2).



Fig. 20: "Method" screen using a function key

### 7.4.2 Correction factor

The correction factor allows correction of the measured leak rate by the detector when it is combined with parallel pumping.

From the "Settings" screen, press [Test].

HV Correction/Sniff. Correction	⇒ Activate the correction factor application. ⇒ Set the correction factor to be applied.
---------------------------------	---



For quick access from the control panel, set a function key for [Correction] (see 7.7.2).

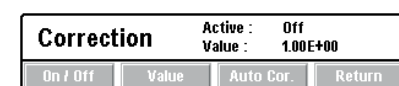

Fig. 21: "Correction" screen using a function key

**Displays: digital and bargraph**

Only the digital display is corrected by the correction factor: the correction factor does not apply to the bargraph display.



**Depending on the concentration of tracer gas used for detecting leaks, the leak rate displayed changes.**

– Example: the leak rate displayed with a calibrated leak of  $1 \cdot 10^{-8} \text{ Pa} \cdot \text{m}^3/\text{s}$  ( $1 \cdot 10^{-7} \text{ mbar} \cdot \text{l/s}$ ) (with 100 %  $^4\text{He}$ ) connected to the detector's inlet.

% He in the gas used	100 %	50 %	5 %	1%
leak rate displayed on the leak detector without correction	$1 \cdot 10^{-8} \text{ Pa} \cdot \text{m}^3/\text{s}$ $1 \cdot 10^{-7} \text{ mbar} \cdot \text{l/s}$	$5 \cdot 10^{-9} \text{ Pa} \cdot \text{m}^3/\text{s}$ $5 \cdot 10^{-8} \text{ mbar} \cdot \text{l/s}$	$5 \cdot 10^{-10} \text{ Pa} \cdot \text{m}^3/\text{s}$ $5 \cdot 10^{-9} \text{ mbar} \cdot \text{l/s}$	$1 \cdot 10^{-10} \text{ Pa} \cdot \text{m}^3/\text{s}$ $1 \cdot 10^{-9} \text{ mbar} \cdot \text{l/s}$
Correction value	1	2	20	100
Leak rate displayed on the leak detector with correction	$1 \cdot 10^{-8} \text{ Pa} \cdot \text{m}^3/\text{s}$ $1 \cdot 10^{-7} \text{ mbar} \cdot \text{l/s}$			

### 7.4.3 Test mode

A hard vacuum test can be performed whenever one of the Gross Leak, Normal or High Sensitivity test modes is turned on.



**For quick access from the control panel, set a function key for [Mode] (see 7.7.2).**



Fig. 22: "Mode" screen using a function key



**By default, the leak detector is set to work in a hard vacuum test, in the normal test mode: this setting meets the majority of the operators' needs.**

**From the "Settings" screen, press [Test].**

Mode	⇒ Set the test mode.
------	----------------------

### 7.4.4 Automatic Cycle End

This function allows automatic control of the roughing time and measurement time in a hard vacuum test.

**From the "Settings" screen, press [Test] [Cycle End].**

Automatic cycle end	⇒ Activate the function. Function activated if 'automatic' is set.
Roughing timer	Setting optional if 'automatic' is set. ⇒ Activate the control for the roughing duration. ⇒ Set the maximum roughing duration allowed. If the control is activated and the duration expires (detector still in roughing) = part rejected.
Test timer	Setting required if 'automatic' is set. ⇒ Set the measurement duration. When the duration expires, the measured leak rate is displayed.



**Function to use to automate small production.**

## 7.4.5 Inlet vent

This function allows an inlet vent after a hard vacuum test stop.

It allows the detector's inlet, and therefore the connected part or installation, to return to atmospheric pressure.

This function is secure: a confirmation message "Inlet vent? Please confirm." appears each time the operator requests an inlet vent.

From the "Settings" screen, press [Test] [Inlet vent].	
Inlet vent	⇒ Activate the function. Function activated if 'automatic' is set.
Delay	Setting required if 'automatic' is set. ⇒ Set the delay. Delay = time between the test stop and the automatic opening of the inlet vent valve. Allows a controlled valve to be closed before inlet vent.
Vent Timer	Setting optional if 'automatic' is set. ⇒ Activate the closing of the inlet vent valve. ⇒ Set the duration. Duration = time between the opening of the air inlet valve and its automatic closing. The automatic closing after a set duration is used to limit consumption of dry air or nitrogen, if purge is connected.



**For quick access from the control panel, set a function key for [Inlet Vent] (see 7.7.2).**

**Activate VENT ? Please confirm.**

Ok

Return

**Fig. 23: "Activate vent" screen using a function key**

If "Automatic" is selected, air enters automatically when  is pressed to stop the test. If 'Operator' is selected, press the corresponding function key to return the detector to atmospheric pressure.

Inlet vent manual activation from:

- the button **[Inlet vent]**
- the "Standard" screen (6) (see 6.1.3).



**To lock the control for the inlet vent valve, delete the [Inlet vent] function key. The icon will stay on the "Standard" screen as an indicator but manual activation by the operator will be deactivated.**



### NOTICE

#### Automatic inlet vent

Never programme 'automatic' inlet vent while the detector is connected to a high vacuum chamber or semi-conductor process chamber!

Select 'Operator' and/or delete the function key allocated to the automatic inlet vent. The inlet vent must be carried out using the menu, which can be password locked.



**By connecting an inlet vent (or nitrogen) line to the inlet vent, the detector's tracer gas pollution is reduced.**

## 7.4.6 Memo function

This function freezes the "Standard" screen and displays the most recent test result: the leak rate displayed flashes.

From the "Settings" screen, press [Test] [Memo Function].	
Active	⇒ Activate the function.

<b>From the "Settings" screen, press [Test] [Memo Function].</b>	
Display time	Setting required if the function is active. ⇒ Activate the display time delay. <ul style="list-style-type: none"> <li>• On = the value of the measured leak rate flashes for the set duration.</li> <li>• Off = the value of the measured leak rate will flash until a new test begins.</li> </ul> ⇒ Set the display duration.



**For quick access from the control panel, set a function key for [Memo] (see 7.7.2).**



Fig. 24: "Memo function" screen using a function key

### 7.4.7 Zero activation

This function is used to help the operator identify very small leak rate variations in the surrounding background or to dilate small measured leak rate fluctuations on the analogical display.

<b>From the "Settings" screen, press [Test] [Zero Activation].</b>	
Activation	⇒ Activate the function (activated if 'automatic' is set).
Trigger	Setting required if 'automatic' is set. ⇒ Set the function trigger factor.
Value	Setting required if 'automatic' is set. ⇒ Set the function trigger value.



**To launch the function manually from the control panel, set a function key to [Zero] (see 7.7.2).**



**Using this function is recommended when the background of the tracer gas is stable and significant. This function is used to measure a leak rate that is lower:**

- than 2 decades in hard vacuum test mode:  $5 \cdot 10^{-13}$  Pa·m<sup>3</sup>/s ( $5 \cdot 10^{-12}$  mbar·l/s) maximum
- than 3 decades in sniffing mode:  $5 \cdot 10^{-10}$  Pa·m<sup>3</sup>/s ( $5 \cdot 10^{-9}$  mbar·l/s) maximum

**than the detector's background, when the detector is no longer in roughing.**



**To deactivate the Zéro [Zero] function key, set the activation to 'None'.**



## 7.5 Spectro Menu

→ From the "Settings" screen, press [Spectro].

Spectro	
Tracer Gas :	Helium 4
Fil. Selected :	#1
Filament :	On
Fil. Status :	100%
Calibrated Leak	

### 7.5.1 Tracer gas

The tracer gas is the gas searched for during a test.  
3 gases are available:  $^4\text{He}$ ,  $^3\text{He}$  and  $\text{H}_2$ .

**From the "Settings" screen, press [Spectro].**

Tracer gas ⇒ Select the tracer gas used.

The reject set point is memorized for each configurable tracer gas.

#### Calibration

The leak detector should be calibrated with a calibrated leak of the same type as the tracer gas used.

#### Hydrogen test



### DANGER

#### Explosion hazard.

For detecting leaks with 'hydrogen' tracer gas, the operator must use hydrogenated nitrogen (mix of 95 %  $\text{N}_2$  and 5 %  $\text{H}_2$ ).

The detector's background is higher in Hydrogen than Helium.

Typical  $\text{H}_2$  background, during a test, when the detector is equipped with a blanking flange on the inlet port:

- at switching on:
  - low range  $\pm 1 \cdot 10^{-6} \text{ Pa} \cdot \text{m}^3/\text{s}$  ( $1 \cdot 10^{-5} \text{ mbar} \cdot \text{l/s}$ )
- after 2 or 3 hours:
  - low range  $\pm 1 \cdot 10^{-7} \text{ Pa} \cdot \text{m}^3/\text{s}$  ( $1 \cdot 10^{-6} \text{ mbar} \cdot \text{l/s}$ )



**For quick access from the control panel, set a function key for [Tracer Gas] (see 7.7.2).**

Tracer Gas :	Helium 4		
Helium 4	Helium 3	Hydrogen	Return

Fig. 25: "Tracer Gas" screen using a function key

### 7.5.2 Filament parameters

Fil. Selected	Indicates the filament used for the measurement (2 filaments in the analyzer cell).
Filament	Indicates if the filament used is 'on' or 'off' when the detector is switched on.
Fil. status	Indicator of analyzer cell performance. Initial settings: between 90 % and 100 % Normal operation: between 10 % and 100 % Normal wear on some cell components will reduce this value over time but will not reduce the accuracy of the detector's measurements.

### 7.5.3 Calibrated leak

See 6.5.

From the "Settings" screen, press [Spectro][Calibrated leak].	
Tracer gas	⇒ Set the tracer gas for the calibrated leak used for calibration.
Type	⇒ Define the type of calibrated leak used for calibration. <ul style="list-style-type: none"> <li>• internal = calibration using the leak detector's internal calibrated leak (<sup>4</sup>He leak only).</li> <li>• external = calibration using an external calibrated leak (<sup>4</sup>He, <sup>3</sup>He or H<sub>2</sub> leaks).</li> </ul>
Unit	⇒ Set the calibrated leak unit used for calibration. <sup>(1)</sup>
Leak Value	⇒ Set the calibrated leak value used for calibration. <sup>(1)</sup>
Calibration valve	⇒ Define the actual status of the calibration valve. Used to open/close the manual calibration valve, for example. Remember to close the valve again after use. <b>Manual calibration is only for experts.</b>
Loss per Year (%)	⇒ Set the loss rate per year for the calibrated leak used for calibration. <sup>(1)</sup>
Ref. T. (°C)	⇒ Set the reference temperature for the calibrated leak used for calibration. <sup>(1)</sup>
Coeff. T. (%/°C)	⇒ Set the temperature coefficient for the calibrated leak used for calibration. <sup>(1)</sup>
Year	⇒ Set the month and year of calibration for the calibrated leak used for calibration. <sup>(1)</sup>
Internal T. (°C) or External T. (°C)	'Internal' indicates the temperature at the detector's internal calibrated leak. 'External' indicates the temperature at the detector's external calibrated leak.

(1) Use the information indicated on the calibrated leak used for calibration or on its calibration certificate.

In case of leak replacement, these parameters must be updated. When the parameters are saved, all the data from all the calibrated leaks set (1 internal leak and 3 external leaks) is memorised.

## 7.6 Maintenance Menu

→ From the "Settings" screen, press [Maintenance].

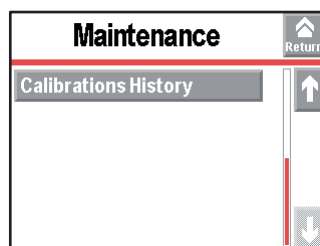
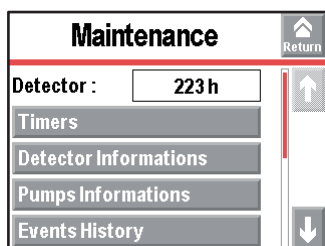

### 7.6.1 Detector

From the "Settings" screen, press [Maintenance].	
Detector	Number of hours that the detector is switched on

### 7.6.2 Timers

From the "Settings" screen, press [Maintenance] [Timers].	
Detector	Number of hours that the detector is switched on.
Filament 1	Number of hours that filament 1 is on. ⇒ Press [xxx h] [Counter reset] to reset the counter.
Filament 2	Number of hours that filament 2 is on. ⇒ Press [xxx h] [Counter reset] to reset the counter.
Calib. Leak	Indicates the month and year of calibration for the calibrated leak used for calibration.
Cycle Counter	Indicates the number of performed cycles since the last reset / the set cycle number. When the set value is reached, an information message is displayed.
Primary Pump	Indicates the number of primary pump operating since the last reset / the set hour number. When the set value is reached, an information message is displayed.

**From the "Settings" screen, press [Maintenance] [Timers].**

Sec. pump # 1	Indicates the number of secondary pump 1 operating since the last reset / the set hour number. When the set value is reached, an information message is displayed.
---------------	---



**For quick access to the counters from the control panel, set a function key for [Maintenance] (see 7.7.2).**

➔ To set the set point and reset the cycle counter,

**From the "Settings" screen, press [Maintenance] [Timers] [xxxx Cy/xxxx Cy].**

Cycles	Indicates as a % the number of cycles made in relation to the interval set.
Counter	Indicates the number of cycles made since the latest reset of the counter.
Interval	⇒ Set the value for the counter. When the set value is reached, an information message is displayed.
Reset Counter	⇒ Press [Counter reset] to reset the counter.

➔ To set the set point and reset the operating hours counter for each pump's ,

**From the "Settings" screen, press [Maintenance] [Timers] [xxxx h/xxxx h] for each pump**

Pump XXX	Indicates as a % the number of operating hours for the pump XXX in relation to the interval set.
Counter	Indicates the number of operating hours for the pump since the latest reset of the counter.
Time interval	⇒ Set the value for the counter. When the set value is reached, an information message is displayed.
Reset Counter	⇒ Press [Counter reset] to reset the counter.

Primary pump: AMD1 Pump.

Secondary pump 1: AMH 020 HLD Pump

### 7.6.3 Detector Information

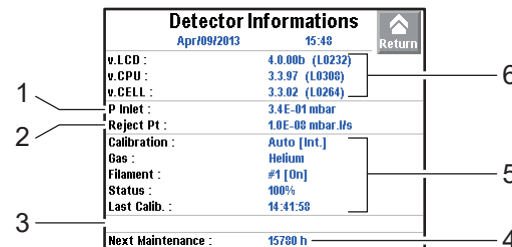

Fig. 26: Detector Information

1	Inlet pressure
2	Reject set point for the test method in progress
3	List of activated functions
4	Primary or secondary pump maintenance
5	Calibration information
6	Detector firmware information



**For quick access from the control panel, set a function key for [Infor.] (see 7.7.2).**

### 7.6.4 Pump Information

#### Primary Pump #1

**From the "Settings" screen, press [Maintenance] [Pump Information] [Prim. Pump #1].**

Used	Control of the pump by the detector
Status	Status of the pump
Speed	Pump status: Max/Min/Nominal
Synchro	Pump at the speed indicated in the firmware

#### Secondary Pump #1

**From the "Settings" screen, press [Maintenance] [Pump Information] [Sec. Pump #1].**

Status	Status of the pump
--------	--------------------

From the "Settings" screen, press **[Maintenance]** **[Pump Information]** **[Sec. Pump #1]**.

Rotation	Pump status: Synchro/Down/Fail/Running/Ram up
Speed (rpm)	Pump running speed

### 7.6.5 Event history

Event history records the last 30 events. Beyond 30, the oldest recorded event will be replaced by the most recent, and so on.

→ From the "Settings" screen, press **[Maintenance]** **[Event History]**.

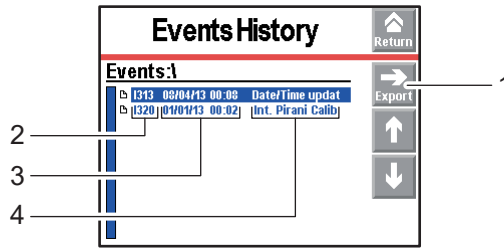

1	Exporting the history in .csv format to the SD card
2	Code for the event
3	Date - Time of the event
4	Description of the event

Event = Error (Exxx) or Warning (Wxxx) or Information (Ixxx)

List of events:

Code	Event	Description
I300	Inlet vent	Inlet vent
I301	Stp on pollution	Test stops automatically if measured leak rate pollution > Pollution
I302	RVP ctr reset	Primary pump hour counter reset.
I303	TMP1 ctr reset	Secondary pump 1 hour counter reset
I306	Fil 1 ctr reset	Filament 1 hour counter reset
I307	Fil 2 ctr reset	Filament 2 hour counter reset
I308	Cycle ctr reset	Cycle counter reset
I310	Autocal restart	Automatic start of a new autocalibration
I313	Date/Time update	Date or time modification
I318	Full param reset	Complete detector parameter reset
I319	Fil change	Filament change (manually or automatically from Maintenance menu)
I320	Int. Pirani Calib.	Automatic internal Pirani gauge calibration
I321	Storage delay	Detector switched off for 15 days (minimum)

## 7.6.6 Calibration history

The calibration history records the last 20 calibrations made. Beyond 20, the oldest recorded calibration will be replaced by the most recent and so on.

→ From the "Settings" screen, press **[Maintenance]** **[Calibration History]**.

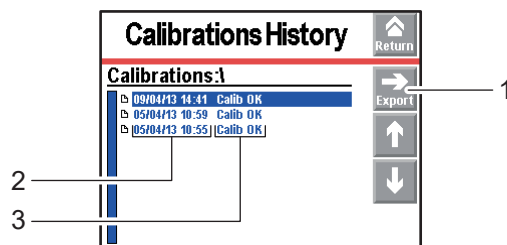

1	Exporting the history in .csv format to the SD card
2	Date - Time of the calibration
3	Calibration result

## 7.7 Configuration Menu

→ From the "Settings" screen, press **[Config.]**.

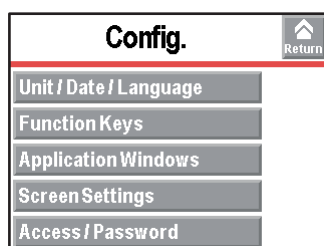

### 7.7.1 Time - Date - Unit - Language

The update of these parameters is automatically requested when the operator switches the detector on for the first time: after this, the operator can modify them at any time.

**From the "Settings" screen, press [Config.] [Unit/Date/Language].**

Unit	⇒ Set the unit to be used. The set points/values set are not automatically converted to the new unit if the unit changes: they must be updated by the operator.
Date	⇒ Set the current date.
Time	⇒ Set the time. The time is not automatically updated when switching from summer time to winter time and vice versa: it must be updated by the operator.
Language	⇒ Set the language.

### 7.7.2 Function keys

The function keys are used to activate/stop a function or to adjust set points.

Per initial settings, the 8 function keys are allocated and distributed over 2 levels: they can be reallocated by the operator.

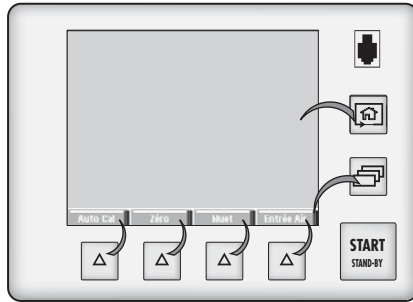

Fig. 27: Function keys

**Allocating function keys** → From the "Settings" screen, press [Config.] [Function Keys].



**Thanks to the function keys, it is possible to give the operator access to a limited number of functions and to use a password to lock unauthorised functions on the "Settings" menu. They are sufficient to manage the detector.**

- To allow the operator to use only the [Start/Stand-by] key, do not allocate a function to the function keys and lock the "Settings" menu.
- Up to 4 additional function keys can be added, for a maximum of 12. In this case, a 3<sup>rd</sup> level is made available to the operator.

Each function key can be allocated to a function chosen by the operator: see the example below.

Example: Allocate the 'Correction' function (1) to the [Mode] function key (2).

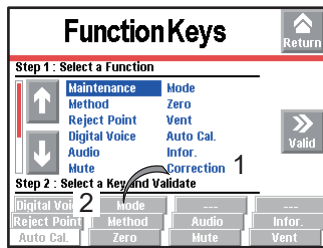

Fig. 28: Allocation objective

→ Select the 'Correction' function (1) using the and .

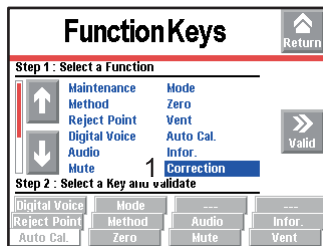

Fig. 29: Selecting the function

→ Select the [Mode] function key (2) by pressing repeatedly (key selected if background is white).

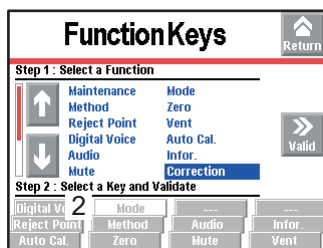

Fig. 30: Selecting the function key

→ Validate the settings (3): the function key (2) is now allocated to the **[Correction]** function.

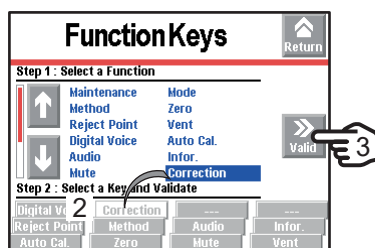



Fig. 31: Result of the allocation

### 7.7.3 Application screens

→ From the "Settings" screen, press **[Config.] [Application Windows]**.

By pressing repeatedly on the key , the various screens available appear (see 6.1.2).

The operator can hide one or more screen or switch the order in which they appear. The "Standard" application screen is always available in 1<sup>st</sup> position.

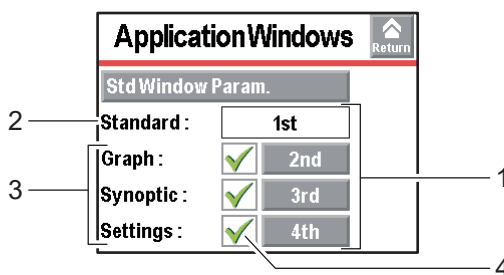

1	Order of the displayed screens with the key 
2	"Standard" application screen always displayed
3	Available screens
4	Displaying/hiding the application screen

The screen order can be modified: press the order number (example: **[3<sup>rd</sup>]**) and use the **+** and **-** to choose the new order number then confirm.

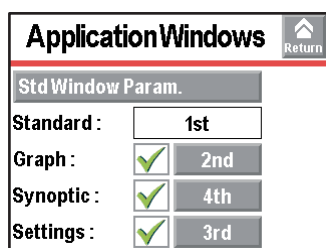



Fig. 32: The "Synoptic" screen order has switched from 3 to 4

When a screen is no longer selected  or if its order has been changed, the general order is automatically updated.

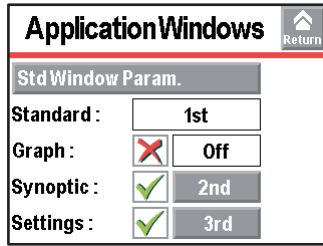

Fig. 33: The "Graph" screen is no longer available

When a screen is selected again, it automatically moves to last place.

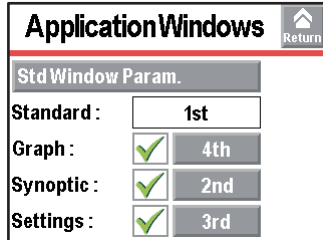

Fig. 34: The "Graph" screen is available again, and in last place.

**Setting the "Standard" screen**

From the "Settings" screen, press [Config.] [Application screens] [Std. Screen setting].	
Std-By value	⇒ Display/Hide the leak rate display in Stand-by mode.
Inlet Pressure	⇒ Display/Hide the inlet pressure display.
Cell pressure.	⇒ Display/Hide the cell pressure display.
Lower Display Limit	Set the minimum value displayed for leak rate. Leak rate not displayed if the value is less than the 'Lower Display Limit' configured value.

From the "Settings" screen, press [Config.] [Application screens] [Std. Std. Screen] [Bar-graph].	
Zoom on set point	⇒ Activate zoom to set point. Zoom to set point is used to display on the bargraph the reject set point centred on 2 decades.
Low Decade	⇒ Set the low decade for the bargraph display.
High Decade	⇒ Set the high decade for the bargraph display.

**7.7.4 Screen Settings**

From the "Settings" screen, press [Config.] [Screen Settings].	
Brightness	⇒ Set the brightness.
Contrast	⇒ Set the contrast.
Panel off	⇒ Activate the sleep mode screen. The screen is in sleep mode when the back light goes off (black screen). The device appears to be off, but this is not the case! Simply touching the screen reactivates the display. By default, automatic sleep mode is not activated. If the screen is out of order, its functions are still accessible: use the RS-232 to manage/set the detector.
Paging Func.	⇒ Activate the Paging function. When a remote control (accessory) is used, the 'Paging' function makes it possible to easily find the remote if it is located within its field of use with the detector. When the function is activated, the remote emits a sound signal so it can be located. To stop the sound signal, deactivate the Paging function.



➔ Press [Reset Panel Param.] to reset the control panel parameters.

**7.7.5 Access - Password**

- ➔ From the "Settings" screen, press [Config.] [Access/Password].
- ➔ Enter the password ('5555' by default) and validate.

**Menu access** The operator can lock access to one or more menus on the "Settings" screen. To access a locked menu, the operator will be asked to provide the password.



- Lock a menu by pressing .
- Unlock a menu by pressing .

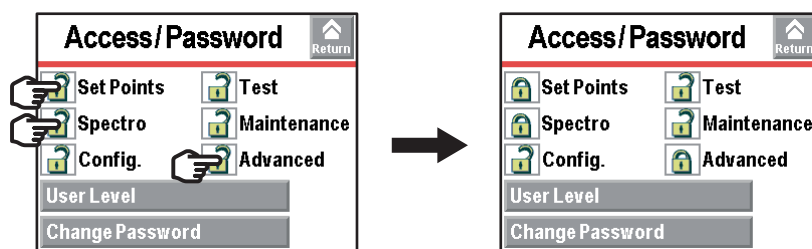



Fig. 35: Example: Locking the Set Points, Spectro and Advanced menus  
On the "Settings" screen, the locked menus are indicated by .

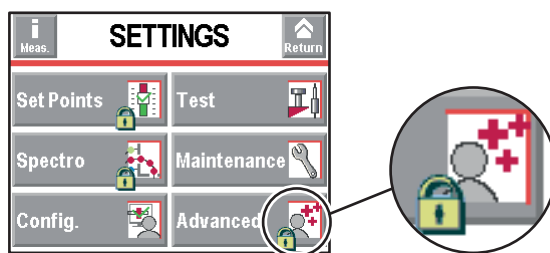

Fig. 36: Locked menus

#### Change password

- From the "Settings" screen, press **[Config.] [Access/Password]**.
- Enter the password ('5555' by default) and validate.
- Press **[Change Password]**.
- Enter the new password and validate.

#### User level

- From the "Settings" screen, press **[Config.] [Access/Password] [User level]**.



3 user levels can be used to restrict the display and operator access to settings and functions:

- restricted access,
- medium access,
- full access.



**If the password is forgotten, it can be found using the RS-232: see operating instructions.**

#### Limits with Restricted access

- Key  invalid: no settings can be made without password.
- Pictogram  invalid.
- Function keys hidden.
- Inlet pressure and cell pressure hidden.
- Key  invalid: launch of a test via a communication interface only.
- Measured leak rate and reject set point displayed only in test.

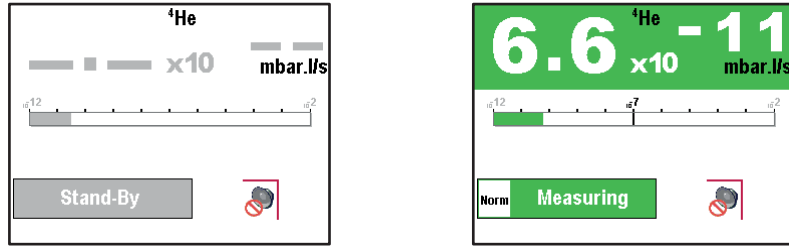



Fig. 37: Displays with Restricted access





**With Medium or Restricted access, the operator can temporarily access the 6 menus on the "Settings" screen to set parameters.**

- Press and hold the key  until the "Settings" screen is displayed with all the locked menus.
- Press the desired menu.
- Enter the current password ('5555' by default) and validate.
- Carry out the desired parameter settings.

**Limits with Medium access**

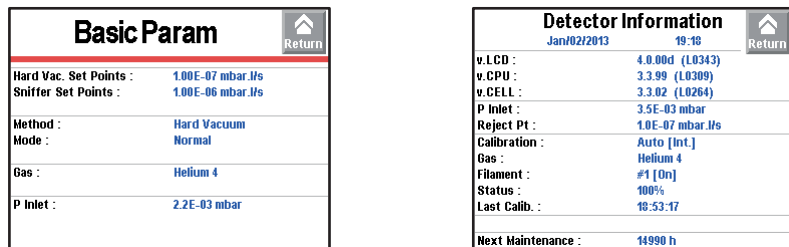
- Key  invalid: no settings can be made without password.
- 2 function keys available: **[Basic Param.]** and **[Info]**.



- Function keys hidden.
- Inlet pressure and cell pressure hidden.
- Key  valid.
- Measured leak rate and reject set point displayed only in test.

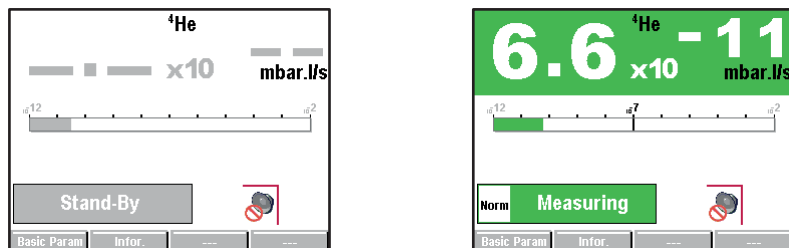



Fig. 38: Displays with Medium access



**With Medium or Restricted access, the operator can temporarily access the 6 menus on the "Settings" screen to set parameters.**

- Press and hold the key  until the "Settings" screen is displayed with all the locked menus.
- Press the desired menu.
- Enter the current password ('5555' by default) and validate.
- Carry out the desired parameter settings.

**Limits with Full access**

- No limit.

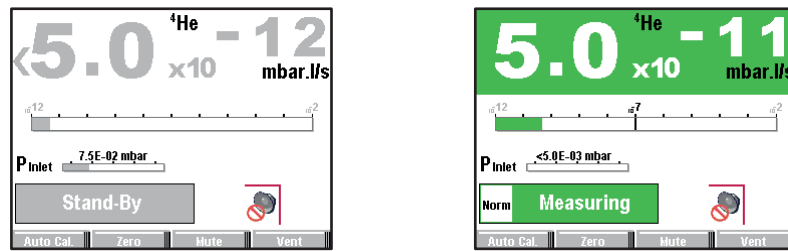



Fig. 39: Displays with Full access

**Operator with Restricted or Medium access changing the access level. →**

Press  until the "Settings" screen is displayed with all the locked menus.

→ Press **[Config.]**.

→ Enter the current password ('5555' by default) and validate.

→ Press **[Access/Password]**.

→ Enter the current password ('5555' by default) and validate.

→ Press **[User Level]**.

→ Change the access level: see below the limits for each level.

**Operator with Full access changing the access level.**

→ From the "Settings" screen, press **[Config.] [Access/Password]**.

→ Enter the current password ('5555' by default) and validate.

→ Press **[User Level]**.

→ Change the access level: see below the limits for each level.

## 7.8 Advanced Menu

The Advanced menu is reserved for leak detection experts and/or for setting a particular product.

→ From the "Settings" screen, press **[Advanced]**.

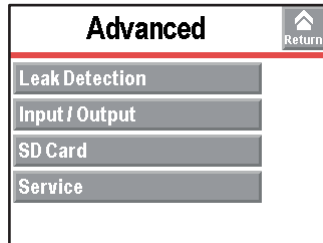

### 7.8.1 Leak Detection Menu

→ From the "Settings" screen, press **[Advanced]** **[Leak Detection]**.

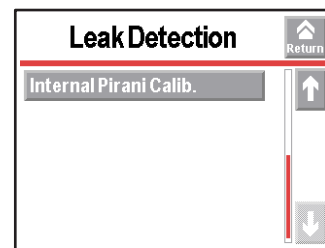
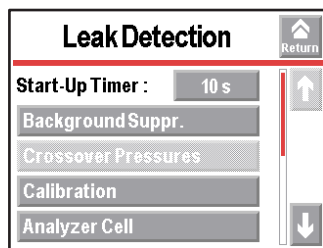

### 7.8.2 Leak Detection: Start-up timer

The start-up timer prevents the leak detector from being used for a pre-determined duration after it has been switched on. This means measurements cannot be made until the leak detector is thermally stabilized, or while traces of tracer gas remain in the detector.

**From the "Settings" screen, press [Advanced][Leak Detection].**

Start-up timer	⇒ Set the start-up timer.
----------------	---------------------------

### 7.8.3 Leak Detection: Background suppression

This function is used to suppress the detector's background.

**From the "Settings" screen, press [Advanced] [Leak Detection] [Background Supp.].**

Activation	⇒ Activate the function ('on' if activated).
------------	--

Note: after calibration, with background suppression function activated, the leak detector's background will be lower than  $5 \cdot 10^{-13} \text{ Pa} \cdot \text{m}^3/\text{s}$  ( $5 \cdot 10^{-12} \text{ mbar} \cdot \text{l/s}$ ).



**This function is recommended for testing very small leaks, which improves measurement and reading.**  
**This function can be used to measure a leak rate 2 decades lower than the detector's background, when the detector is no longer in roughing.**

### 7.8.4 Leak Detection: Crossover Pressures

Not available

## 7.8.5 Leak Detection: Calibration



### NOTICE

#### Detector calibration

When switched on, the detector suggests that the operator carry out an auto-calibration (if calibration parameter = 'operator'). For the optimal use of the detector, **this auto-calibration must be performed**. In all situations, a manual or automatic calibration must be performed:

- at least once a day
- to optimise the measurement reliability for high sensitivity tests
- if it is uncertain whether the detector is working properly
- during intense and continuous operation: start an internal calibration at the beginning of each work session (e.g. work in teams, every 8 hours).

Calibration makes it possible to verify that the detector is properly adjusted to detect the selected tracer gas and display the correct leak rate value.

**From the "Settings" screen, press [Advanced] [Leak Detection] [Calibration].**

Calibration	⇒ Select the type of calibration. See details below.
-------------	--

Calib.Checking	⇒ Activate the calibration checking and set the frequency. See details below.
----------------	---

If there is no internal calibrated leak, calibration can be performed with an external calibrated leak. By default, autocalibration is set to 'On' and the internal leak is selected so that the detector can be calibrated quickly.

#### Calibration = 'operator'

Calibration started by the operator.

→ Press the [AUTOCAL].

If calibration does not start within 20 minutes after the leak detector is switched on, message is displayed.

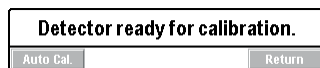

Fig. 40: Leak detector ready for calibration

#### Calibration = 'start-up'

Calibration starts automatically when the leak detector is switched on.

#### Calibration = 'manual'

Calibration starts manually.

#### Operation reserved for service centers and experts only.

The leak detector can also be calibrated using an external leak (see 6.5).

Calibration control saves the operator time because the calibration control is quicker than the full calibration.

#### "Calibration control" setting

If calibration = 'operator' or 'start-up', the calibration control function performs a control of the calibration according to the parameters set.

The calibration control is deactivated if calibration = 'manual'.

The calibration control is performed with the leak detector's internal calibrated leak (leak type parameter = 'internal').

The leak detector compares the measured leak rate of the internal calibrated leak with the set leak rate of the internal calibrated leak:

- If the ratio is within the limits allowed, the leak detector is properly calibrated.
- If the ratio is outside those limits, a message appears suggesting that a full calibration of the leak detector be started.

Checking	⇒ Select the type of calibration (activated if 'automatic' has been set).
----------	---

Frequency	⇒ Set the set points (cycles and times) for triggering the calibration control. The first set point reached will trigger the control.
-----------	---

**To launch the function from the control panel, set a function key to [Check Cal].**





**At any time, the operator can start a leak detector calibration control: detector in Stand-by mode, press the [AUTOCAL] function key twice within 5 seconds.**

### 7.8.6 Leak Detection: Analyzer cell

From the "Settings" screen, press [Advanced] [Leak Detection] [Analyzer Cell].	
Fil. Selected	Indicates the filament used for the measurement (2 filaments in the analyzer cell).
Filament	Indicates if the filament used is 'on' or 'off' when the detector is switched on.
<ul style="list-style-type: none"> <li>- Triode pressure</li> <li>- Elec.Zero</li> <li>- Target value</li> <li>- Acc. voltage (V)</li> <li>- Emission (mA)</li> <li>- Coeff. Sens.</li> </ul>	Parameters for manual calibration. <b>This type of calibration is reserved for service centers and leak detection experts only.</b>
Calib. valve	⇨ Define the actual status of the calibration valve. Used to open/close manually the calibration valve, for example. Remember to close the valve again after use. <b>Manual calibration is only for experts.</b>
Internal T (°C) or External T (°C)	'Internal' indicates the temperature at the detector's internal calibrated leak. 'External' indicates the temperature at the detector's external calibrated leak.



**Do not switch off the filament except for carrying out manual calibration. It is not necessary to switch the filament off in Stand-by mode to save it.**

- The leak detector switches automatically from one filament to the other if the selected filament currently being used becomes defective.
- When switched on, the leak detector uses the filament that was selected when it was shut down.

### 7.8.7 Leak Detection: Internal Pirani gauge calibration

This function is used to calibrate the detector's internal gauge.

- Procedure**
- From the "Settings" screen, press **[Advanced] [Leak Detection] [Internal Pirani Calib.]**.
  - Block the detector's inlet with a blanked-off flange.
  - Make sure:
    - that the leak detector is in a hard vacuum test, in the most sensitive test mode.
    - that the end of the cycle is manual (= 'operator').

The calibration takes place in 2 stages: setting the limit pressure and setting the atmospheric pressure.

- Setting the limit pressure**
- Make sure that the internal pressure is significantly lower than  $1 \cdot 10^{-3}$  hPa.
  - Start a test: press  .
  - The "Pressure" value decreases: wait for this value to stabilise (around 5 minutes) and press the **[>HV]**.

- Setting the atmospheric pressure**
- Stop the test: press the  .
  - Create an inlet vent: press **[Inlet vent]**.
  - Make sure that the detector is at atmospheric pressure.
  - The "Pressure" value increases: wait for this value to stabilise (around 5 minutes) and press the **[>Atm]**.

### 7.8.8 Input/Output menu

- From the "Settings" screen, press **[Advanced] [Input/Output]**.

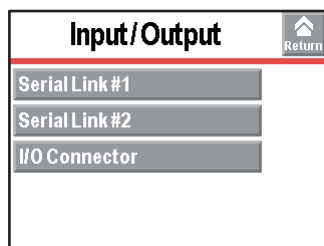

### 7.8.9 Input/Output: Serial Link 1 and Serial Link 2

From the "Settings" screen, press [Advanced] [Input/Output], then [Serial Link 1] or [Serial Link 2].

Type	⇒ Set the type of serial link: see table below.
Parameters	⇒ Set the serial link mode: see detail below.

The operator must allocate the 2 serial links (1 and 2) according to their use.

Operation	Possible allocation		Type to select
	Serial Link 1	Serial Link 2	
RS 232	yes	no	Serial
Wireless remote control (1)	yes	no	Serial
(1) Accessory			

**Parameters** → From the "Settings" screen, press [Advanced] [Input/Output] [Serial Link 1] or [Serial Link 2][Parameters].

Available modes:

Mode	Description
Basic	Continuous acquisition of data sent to the hyperterminal according to a defined time duration. At any time, a command can be sent to the leak detector. <b>Recommended mode during leak detector test procedure setting operations.</b>
Spreadsheet	Variation of the Basic mode. Continuous data acquisition, formatted in a spreadsheet such as Excel Microsoft® Office or other similar software. <b>Recommended mode for drawing curves.</b>
Advanced	Full control of the detector by a supervisor. The detector sends information at the supervisor's request. 5 V power supply available. <b>Recommended mode for automatic systems.</b>
Data Export	Export, via a PC, of "tickets" issued by the detector after: <ul style="list-style-type: none"> <li>• Calibration with an internal/external calibrated leak,</li> <li>• Calibration control with an internal leak,</li> <li>• A test.</li> </ul> <b>Serial links 1 and 2 must not be in "Export Data" mode at the same time.</b>

### 7.8.10 Input/Output: I/O connector

→ From the "Settings" screen, press [Advanced] [Input/Output] [I/O Connector].

The detector is equipped with a 15 pin I/O interface (see *15 pin I/O board Operating instructions*).

### 7.8.11 SD Card menu

From the "Settings" screen, press [Advanced] [SD card].

Load Detector Param.	⇒ Load the saved parameters onto the SD card.
----------------------	---

**From the "Settings" screen, press [Advanced] [SD card].**

Save Detector Param.	⇒ Save the leak detector parameters to the SD card.
View * BMP	⇒ View the saved ".bmp" files.



**Creating a library of the configurations for each application is recommended if the detector is used for more than one application.  
Any SD card on the market can be used except cards with High Capacity technology, regardless of the memory size. Before use, make sure that the SD card is not locked (message "SD card not detected" displayed).**

### 7.8.12 Service

Access to the Service menu is password protected. Reserved for the Busch Service Centers.



## 8 Maintenance / replacement



### NOTICE

#### Disclaimer of liability

Busch accepts no liability for personal injury or material damage, losses or operating malfunctions due to improperly performed maintenance. The liability and warranty entitlement expires.

### 8.1 Maintenance intervals and responsibilities

The detector maintenance operations are described in the *Maintenance instructions* for the detector.

The manual specifies:

- maintenance intervals
- maintenance instructions
- shutting the product down
- tools and spare parts.

Please contact your local Busch company for maintenance support.

## 9 Service

### **Busch offers first-class customer service!**

- On-Site maintenance for many products
- Overhaul/repair at the nearby Service Location

Detailed information, addresses and forms at: [www.buschvacuum.com/services](http://www.buschvacuum.com/services).

### **Overhaul and repair at the Busch Service Center**

The following general recommendations will ensure a fast, smooth servicing process:

- Fill out the "Service Request/Product Return" form and send it to your local Busch Service contact.
- Include the confirmation on the service request from Busch with your shipment.
- Fill out the declaration of contamination and include it in the shipment (mandatory!). The Declaration of contamination is valid for any product/device including a part exposed to vacuum.
- Dismantle all accessories and keep them.
- Close all the flange opening ports by using the original protective covers or metallic airtight blank flanges for contaminated devices.
- If possible, send the pump or unit in its original packaging.

### **Sending contaminated pumps or devices**

No devices will be accepted if they are contaminated with micro-biological, explosive, or radioactive substances. "Hazardous substances" are substances and compounds in accordance with the hazardous goods regulations (current version).

- Neutralize the pump by flushing it with nitrogen or dry air.
- Close all openings airtight.
- Seal the pump or device in suitable protective film.
- Return the pump/device only in a suitable and sturdy transport container and send it in while following applicable transport conditions.

Pump or device returned without declaration of contamination form fully completed and/or not secured in suitable packaging will be decontaminated and/or returned at the shipper's expense.

### **Exchange or repair**

The factory operating parameters are always pre-set with exchange or repaired devices. If you use specific parameters for your application, you have to set these again.

### **Service orders**

All service orders are carried out exclusively according to our general terms and conditions for the repair and maintenance, available on our website.

## 10 Accessories

Description	Part number
Power connection, 2.5 m, UK	0985230815
Helium spray gun	0995230816
Sniffer Probe, 5 m hose, 9 cm long tip	0659230817
Inlet filter 5 $\mu\text{m}$ <sup>1)</sup>	0945232413
Inlet filter 40 $\mu\text{m}$ <sup>1)</sup>	0945232414
Transport trolley	0943230818
Transport box	0855230820

1) Use an inlet filter affects the pumping time.

# 11 Technical data and dimensions

## 11.1 General

Databases of the leak detectors' technical characteristics Busch:

- Technical characteristics according to:
  - AVS 2.3: Procedure for calibrating gas analyzers of the mass spectrometer type.
  - EN 1518: Non-destructive testing. Leak testing. Characterization of mass spectrometer leak detectors.
  - ISO 3530: Methods of calibrating leak-detectors of the mass-spectrometer-type used in the field of vacuum technology.
- Zero function or background suppression activated, in standard conditions (20 °C, 5 ppm <sup>4</sup>He ambient, degassed detector).
- Acoustic pressure level: distance in relation to the detector 1 m.

## 11.2 Technical data

Parameter	TAPIR HL 1102 A
Dimensions (L x W x H)	350 x 254 x 415 mm
Flange (in)	DN 25 ISO-KF
Pumping speed for He	1.1 l/s
Backing pump capacity	1.7 m <sup>3</sup> /h
Start-up time (20°C) with calibration	< 3.5 min
Start-up time (20°C) without calibration	< 2 min
Noise level	< 45 dB (A)
Power consumption max.	300 W
Operating temperature	10-40 °C
Max. inlet test pressure	15 hPa
Weight	21 kg
Detectable gases	<sup>4</sup> He, <sup>3</sup> He, H <sub>2</sub>
Test method	Vacuum and sniffing leak detection
Minimum detectable leak rate for helium (sniffing leak detection)	1 · 10 <sup>-8</sup> Pa m <sup>3</sup> /s
Minimum detectable leak rate for helium (vacuum leak detection)	5 · 10 <sup>-13</sup> Pa m <sup>3</sup> /s
Supply	90-240 V, 50/60 Hz
Backing pump	with oil free backing pump
<b>Environmental conditions</b>	
Storage temperature	- 25 °C à + 70 °C
Maximum humidity of air	95 % without condensing
Maximum magnetic field	3 mT

## 11.3 Units of measurement

Conversion table: pressure units

	mbar	bar	Pa	hPa	kPa	Torr mm Hg
mbar	1	1 · 10 <sup>-3</sup>	100	1	0.1	0.75
bar	1000	1	1 · 10 <sup>5</sup>	1000	100	750
Pa	0.01	1 · 10 <sup>-5</sup>	1	0.01	1 · 10 <sup>-3</sup>	7.5 · 10 <sup>-3</sup>
hPa	1	1 · 10 <sup>-3</sup>	100	1	0.1	0.75
kPa	10	0.01	1000	10	1	7.5
Torr mm Hg	1.33	1.33 · 10 <sup>-3</sup>	133.32	1.33	0.133	1

1 Pa = 1 N/m<sup>2</sup>

**Conversion table: gas throughput units**

	<b>mbar·l/s</b>	<b>Pa·m<sup>3</sup>/s</b>	<b>sccm</b>	<b>Torr·l/s</b>	<b>atm·cm<sup>3</sup>/s</b>
mbar·l/s	1	0.1	59.2	0.75	0.987
Pa·m <sup>3</sup> /s	10	1	592	7.5	9.87
sccm	$1.69 \cdot 10^{-2}$	$1.69 \cdot 10^{-3}$	1	$1.27 \cdot 10^{-2}$	$1.67 \cdot 10^{-2}$
Torr·l/s	1.33	0.133	78.9	1	1.32
atm·cm <sup>3</sup> /s	1.01	0.101	59.8	0.76	1

## 11.4 Dimensions

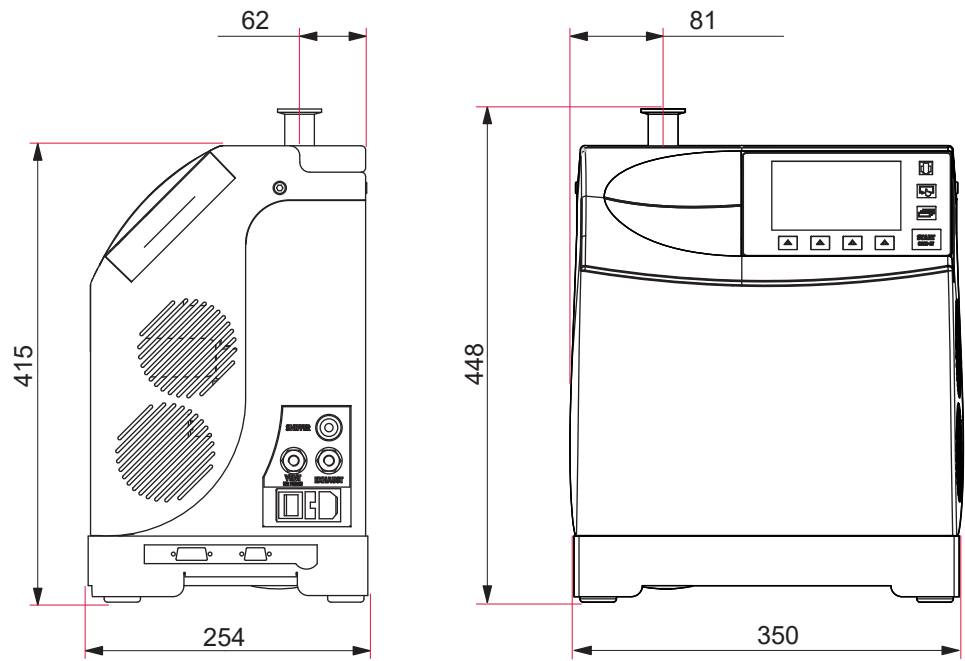

# EU Declaration of Conformity

This Declaration of Conformity and the CE-markings affixed to the nameplate are valid for the machine within the Busch scope of delivery. This Declaration of Conformity is issued under the sole responsibility of the manufacturer.

When this machine is integrated into a superordinate machinery the manufacturer of the superordinate machinery (this can be the operating company, too) must conduct the conformity assessment process for the superordinate machine or plant, issue the Declaration of Conformity for it and affix the CE-marking.

The manufacturer:

**Busch Produktions GmbH**  
**Schauinslandstr. 1**  
**79689 Maulburg**  
**Germany**

declares that the machine: TAPIR HL 1102 A

fulfill(s) all the relevant provisions from EU directives:

- 'Machinery' 2006/42/EC (Annex II, No. 1 A)
- 'Electromagnetic Compatibility' (EMS) 2014/30/EU
- 'RoHS' 2011/65/EU Restriction of the use of certain hazardous substances in electrical and electronic equipment (incl. all related applicable amendments)
- 'Waste of Electrical and Electronical Equipments' 2012/19/EU

and comply(-ies) with the following designated standards that have been used to fulfill those provisions:

Standards	Title of the Standard
EN 60204-1 : 2018	Safety of machinery - Electrical equipment of machines - Part 1: General requirements
EN 61326-1: 2021	Electrical equipment for measurement, control and laboratory use. EMC requirements. General requirements
EN 50581: 2013	Technical documentation for the assessment of electrical and electronic products with respect to the restriction of hazardous substances

Legal person authorized to compile the technical file  
and authorized representative in the EU  
(if the manufacturer is not located in the EU):

Busch Dienste GmbH  
Schauinslandstr. 1  
DE-79689 Maulburg

Maulburg, 23.03.2023



**Dr. Martin Gutmann**  
**General Manager**  
**Busch Produktions GmbH**

# UK Declaration of Conformity

This Declaration of Conformity and the UKCA-markings affixed to the nameplate are valid for the machine within the Busch scope of delivery. This Declaration of Conformity is issued under the sole responsibility of the manufacturer.

When this machine is integrated into a superordinate machinery the manufacturer of the superordinate machinery (this can be the operating company, too) must conduct the conformity assessment process for the superordinate machine or plant, issue the Declaration of Conformity for it and affix the UKCA-marking.

The manufacturer:

**Busch Produktions GmbH**  
**Schauinslandstr. 1**  
**79689 Maulburg**  
**Germany**

declares that the machine: TAPIR HL 1102 A

fulfill(s) all the relevant provisions from UK legislations:

- Supply of Machinery (Safety) Regulations 2008
- Electrical Equipment (Safety) Regulations 2016
- Electromagnetic Compatibility Regulations 2016
- The Restriction of the Use of Certain Hazardous Substances in Electrical and Electronic Equipment Regulations 2012

and comply(-ies) with the following designated standards that have been used to fulfill those provisions:

Standards	Title of the Standard
EN 60204-1 : 2006	Safety of machinery - Electrical equipment of machines - Part 1: General requirements
EN 61326-1: 2013	Electrical equipment for measurement, control and laboratory use. EMC requirements. General requirements
EN 50581: 2013	Technical documentation for the assessment of electrical and electronic products with respect to the restriction of hazardous substances

Legal person authorized to compile the technical file  
and importer in the UK  
(if the manufacturer is not located in the UK):

Busch (UK) Ltd  
30 Hortonwood  
Telford - UK

Maulburg, 23.03.2023



**Dr. Martin Gutmann**  
**General Manager**  
**Busch Produktions GmbH**



---

# Notes

A large grid of small dots, intended for taking notes. The grid consists of approximately 30 columns and 40 rows of dots, covering most of the page area below the header and above the footer.

---

# Notes

A large grid of small dots, intended for taking notes. The grid consists of approximately 30 columns and 40 rows of dots, providing a structured space for writing.

---

# Notes

A large grid of small dots, intended for taking notes. The grid consists of approximately 30 columns and 40 rows of dots, covering most of the page area below the header.

# Busch

## Vacuum Solutions

With a network of over 60 companies in more than 40 countries and agencies worldwide, Busch has a global presence. In every country, highly competent local personnel delivers custom-tailored support backed by a global network of expertise. Wherever you are. Whatever your business. We are there for you.



● Busch companies and Busch employees   ● Local representatives and distributors   ● Busch production site

[www.buschvacuum.com](http://www.buschvacuum.com)