

DOLPHIN LR 0210/0300 A

Liquid ring vacuum pumps



VACUUM SOLUTIONS



Robust

Proven technology, reliable operation, extremely high vapor and particle tolerance, specially designed for challenging environments like mining, power plants, sugar production, pulp and paper industry, steel production etc.

High performance

High-capacity, high pumping speeds

Flexible

Modular design, choice of cast iron (EN-GJL-200) housing with ductile cast iron impeller or all 304 grade, or 316L grade corrosion-free stainless steel material, operating fluids other than water possible, operation as compressor possible

Accessories, spare parts and options

- Motorized pumpsets, with gearbox or V-belt drive system
- Sturdy, steel mounting baseframes
- Partial or total recirculation systems
- Cavitation protection
- Gas ejector
- Non-return valves
- Vacuum relief valves
- Temporary inlet screens (for commissioning)

DOLPHIN LR 0210/0300 A

Liquid ring vacuum pumps



VACUUM SOLUTIONS

Dimensional drawing

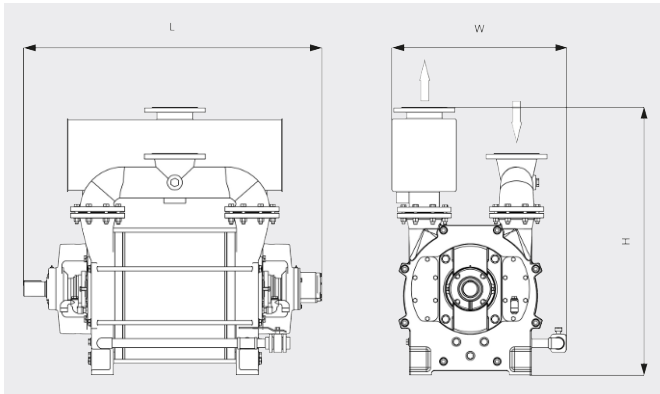

Pumping speed

Dry air at 20°C. Tolerance: ± 10%, in accordance with HEI and Pneurop 6612

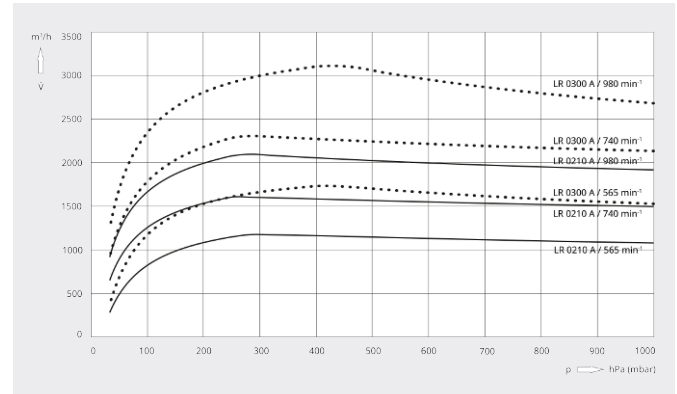

| | DOLPHIN LR 0210 A | DOLPHIN LR 0300 A |
|---------------------------------|-------------------------------|-------------------------------|
| Nominal pumping speed | 1175 – 2100 m ³ /h | 1670 – 3010 m ³ /h |
| Ultimate pressure | 33 hPa (mbar) | 33 hPa (mbar) |
| Nominal motor rating | 30 – 75 kW | 45 – 110 kW |
| Rotational speed of vacuum pump | 565 – 980 min ⁻¹ | 565 – 980 min ⁻¹ |
| Noise level (ISO 2151) | ≤ 85 dB(A) | ≤ 85 dB(A) |
| Weight approx. | 910 kg | 1025 kg |
| Dimensions (L x W x H) | 1238 x 814 x 1245 mm | 1388 x 814 x 1245 mm |
| Gas inlet / outlet | DN 150 PN 10 / DN 150 PN 10 | DN 150 PN 10 / DN 150 PN 10 |

DO YOU WANT TO KNOW MORE?

Get in touch with us directly!
sales@buschindia.com or +91 (0)124 475 1300



CONTACT FORM



CALL NOW