

DOLPHIN LR 0700/1190 A

Liquid ring vacuum pumps



VACUUM SOLUTIONS



Robust

Proven technology, reliable operation, extremely high vapor and particle tolerance, specially designed for challenging environments like mining, power plants, sugar production, pulp and paper industry, steel production etc.

High performance

High-capacity, high pumping speeds

Flexible

Modular design, choice of cast iron (EN-GJL-200) housing with ductile cast iron impeller or all 304 grade, or 316L grade corrosion-free stainless steel material, operating fluids other than water possible, operation as compressor possible

Accessories

- Motorized pumpsets, with gearbox or V-belt drive system, mounted on sturdy steel base frames
- Partial or total recirculation systems
- Cavitation protection
- Gas ejector
- Non-return valves
- Vacuum relief valves

DOLPHIN LR 0700/1190 A

Liquid ring vacuum pumps



VACUUM SOLUTIONS

Dimensional drawing

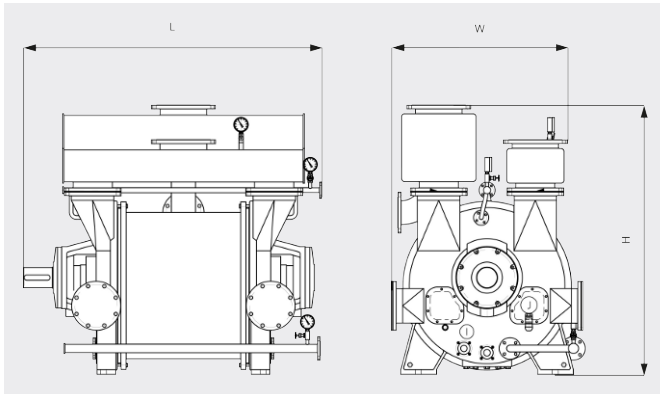

Pumping speed

Air at 20°C. Tolerance: ± 10%

— 50 Hz 60 Hz

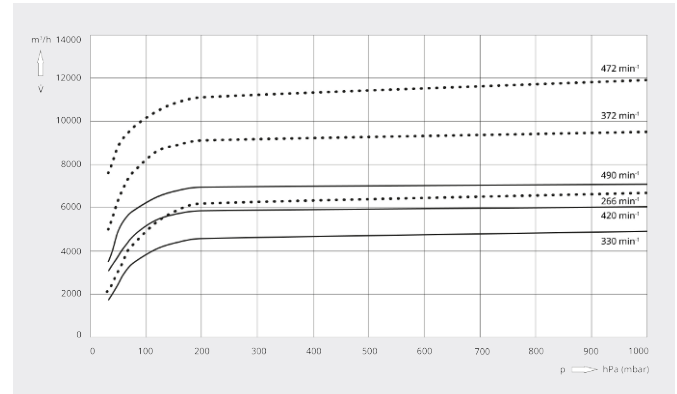

	DOLPHIN LR 0700 A	DOLPHIN LR 1190 A
Nominal pumping speed	4920 – 7000 m ³ /h	6700 – 11900 m ³ /h
Ultimate pressure	33 hPa (mbar)	33 hPa (mbar)
Nominal motor rating	110 – 200 kW	160 – 355 kW
Nominal motor speed	330 – 490 min ⁻¹	266 – 472 min ⁻¹
Noise level (ISO 2151)	< 85 dB(A)	< 85 dB(A)
Weight approx.	3750 kg	5390 kg
Dimensions (L x W x H)	2020 x 1350 x 1865 mm	2258 x 1550 x 2160 mm
Gas inlet / outlet	DN 300 PN 10 / DN 300 PN 10	DN 350 PN 10 / DN 350 PN 10

DO YOU WANT TO KNOW MORE?

Get in touch with us directly!
busch@buschvacuum.hu or +36 24 887 308



CONTACT FORM



CALL NOW