

Mobile Gauge

Vacuum Measurement Equipment
VACTEST TRP 701 D, VACTEST TRP 901 D

Instruction Manual



Table of Contents

1	Safety	3
2	VACTEST TRP 701/901 D	4
2.1	For Orientation	4
2.2	Delivery Content.....	4
2.3	Product Description	4
2.4	Proper Use	4
2.5	Improper Use.....	5
3	Installation	6
3.1	Notes for Installation.....	6
3.2	Vacuum Connection.....	6
3.3	USB Interface.....	7
4	Operation	8
4.1	General	8
4.2	Handling	9
4.3	Start and Stop Data Logging	11
4.4	Graph.....	12
4.5	Calculation of Leakage Rates.....	13
4.6	Settings.....	14
4.6.1	Logging Mode.....	15
4.6.2	Diagram-Options	17
4.6.3	Sensor	19
4.6.4	Device Settings	21
5	Device Information	29
6	VACTEST Explorer Software	31
7	Maintenance and Service	32
7.1	Errors and Malfunctions.....	32
7.2	Important Notes for Disposal.....	33
8	Technical Data	34
9	EU Declaration of Conformity	35
10	UK Declaration of Conformity	36

1 Safety

- Read and follow the instructions of this manual.
- Inform yourself regarding hazards, which can be caused by the product or arise in your system.
- Comply with all safety instructions and regulations for accident prevention.
- Check regularly that all safety requirements are being complied with.
- Take account of the ambient conditions when installing your gauge. The protection class is IP 40 (the unit is protected against penetration of foreign bodies).
- Adhere to the applicable regulations and take the necessary precautions for the process media used.
- Consider possible reactions between materials and process media, e.g. due to the heat generated by the product.
- Before you start working, find out whether any of the vacuum components are contaminated.
- Do not carry out any unauthorized conversions or modifications on the unit.
- Adhere to the relevant regulations and take the necessary precautions when handling contaminated parts.
- When returning the unit to us, please enclose a declaration of contamination.
- Communicate the safety instructions to other users.

This instruction manual highlights potential hazards where appropriate. Safety notes and warning messages are tagged with one of the keywords DANGER, WARNING, CAUTION, NOTICE and NOTE as follows:



DANGER

... indicates an imminent dangerous situation that will result in death or serious injuries if not prevented.



WARNING

... indicates a potentially dangerous situation that could result in death or serious injuries.



CAUTION

... indicates a potentially dangerous situation that could result in minor injuries.



NOTICE

... indicates a potentially dangerous situation that could result in damage to property.



NOTE

... indicates helpful tips and recommendations, as well as information for efficient and trouble-free operation.

2 VACTEST TRP 701/901 D

2.1 For Orientation

These operating instructions describe installation and operation of the VACTEST TRP 701/901 D .

The article number can be found on the product's type label. Technical modifications are reserved without prior notification.

2.2 Delivery Content

Included in the delivery consignment are:

- VACTEST TRP 701/901 D
- Protective flange cover
- Cable USB-C / USB-A
- Instruction manual

Available Accessories:

- Protective case
- Plug-in power supply 5 V
- Windows Software VACTEST Explorer

For further accessories (centering, baffles, KF clamps, etc.) please contact your local Busch sales company.

2.3 Product Description

The VACTEST TRP 701/901 D is measuring total gas pressure in the range 1 - 2000 mbar, additionally relative pressure in a maximum range of -1060 ... +340 mbar.

The VACTEST TRP 701/901 D is equipped with a piezo-resistive ceramic sensor and temperature compensated. Additionally, the gauge operates a piezo-resistive sensor for measuring ambient pressure. It must be mounted to suitable flange connectors or can be operated directly under vacuum.

Due to the integrated data logger functionality, it is possible to store multiple measurements in the device. By means of the USB or an optional Bluetooth interface you can transmit the stored measurement data to a PC or record measurements online on PC as well.

2.4 Proper Use

NOTE

The device is not designed for use in a corrosive atmosphere!

Dust, oil or condensing vapours will affect sensor performance and may cause malfunctions!

Aggressive media such as halogenides, carbon or oxygen plasma can reduce the devices lifetime!

NOTE

Sensor performance issue and malfunction!

Dust, oil or condensing vapors will affect sensor performance and may cause malfunction!

The TRP 701/901 D serves exclusively to provide absolute and relative pressure measurements in gaseous media. It may only be connected to components specifically provided for such purpose. Please respect the admissible overload.

2.5 Improper Use

The use for purposes not mentioned above is regarded as improper, in particular:

- Connection to components containing touchable, voltage carrying parts.
- Connection to units which are not suitable for this purpose according to their operating instructions.

In case of improper use the protection provided by the equipment may be impaired, no liability or warranty will be accepted for claims arising.

The user bears the responsibility with respect to the used process media. The equipment is intended for integration in an end-use system. Suitability of the final combination shall be evaluated in the end-use.

3 Installation



NOTE

The device shall be installed by trained personnel only. Unauthorized modifications of the instrument are not allowed!

3.1 Notes for Installation

Installation location: Indoor

Temperature: +5 °C ... +50 °C

Rel. humidity: max. 80% up to 30 °C, max. 50% at 40 °C, non-condensing

3.2 Vacuum Connection



CAUTION

Unintended opening of clamp with an overpressure in the vacuum system over 1000 mbar.

Risk to injury!

Damage to your health!

- Parts may fly around.
- Unsecured hose connections can release process media.



CAUTION

Overpressure in the vacuum system over 1500 mbar

Damage to your health!

The elastomer washers cannot withstand the pressure and can release process media.

- Use sealing rings with an outer centering ring.



NOTE

When mounting the VACTEST avoid forced twisting or violent opening. This can damage the device.



NOTICE

Dirt and damage at the vacuum flange and/or thread connection.

Impairs the function of the gauge!

- Make sure that the flange and/or thread connection is/are clean, dry and free of grease.
- When handling the instrument, make sure that the flange and/or thread connection is/are protected against dirt and damage.

- Remove the protective cover (is required again during maintenance work!).
- Make vacuum connection via ISO KF small flange or thread connector.
- For small flange connection use clamps that can be opened and closed with appropriate tools only, use sealing rings with a centering ring.
- Make sure that the sensor flange is connected to ground, e.g. by having electrical contact to grounded vacuum chamber (use metallic clamps).

The device may be mounted in any orientation. Mounting with the flange to the top, however, can lead to early contamination and malfunction. An upright orientation with flange to the bottom is to be preferred in order to keep particles and condensates out of the sensor cell. Further the device is adjusted in the upright position ex works.

3.3 USB Interface



WARNING

Improper supply voltage as well as charging the device at ambient temperatures above 40°C can damage the device!



WARNING

The USB connector must not be used to charge other external devices!



NOTE



To recharge the device, commercially available USB-C charging adapters as well as accessory mains adapter can be used.

The vacuum meter has a serial USB 2.0 interface with a corresponding USB-C socket located at the top of the device. In combination with PC Software VACTEST Explorer live measurements or stored data can be uploaded to a PC, further the device settings can be adjusted on PC.

If device settings are made accordingly the VACTEST TRP 701/901 D will act as USB Mass-Storage-Device.

The USB connection is also used to recharge the internal battery. The charging process will be started as soon as the device is connected to a PC or a suitable charging adapter.

OPTIONAL

The VACTEST TRP 701 D is equipped with a Bluetooth® Low Energy interface. It can be used for wireless upload of measurements or stored measurement data.

4 Operation

4.1 General

Measurement Principle

The VACTEST TRP 701/901 D is equipped with an internal ceramic diaphragm sensor. Another piezo-resistive sensor measures ambient pressure.

Under the influence of pressure, the thin diaphragm of the piezo-resistive sensor is bent, on the back of which a resistor-bridge is applied. The bending forces the measuring bridge to come out of tune, which is a measure for the applied pressure. For relative pressure output the ambient pressure is subtracted from the measured absolute pressure inside the sensor flange.

Warm-Up Time

The signal output is available approx. 2 seconds after the device is switched on. To take advantage of the maximum accuracy of the unit it is appropriate to allow for a stabilization time of 5 minutes, especially when extreme pressure changes have occurred.





Accuracy

The device is adjusted ex works in upright position with the flange axis horizontally. Through contamination, ageing or extreme climatic conditions the need for readjustment may arise.

4.2 Handling

Press the OK-Key to switch on the device. After approx. 2 seconds the display will show the measurement menu with the actual pressure. To switch off the device press and hold the OK-Key for 3 seconds.



- 
Measurement: Change operation mode / Keylock
Menu: Move upwards / Increment input value
- 
Measurement: Change additional info / Reset Min/Max
Menu: Move downwards / Decrement input value
- 
Measurement: Select main menu / Switch on/off
Menu: Confirm
- 
Measurement: Switch between absolute and relative pressure
Menu: Move left / Skip into previous menu
- 
Measurement: Switch between absolute and relative pressure
Menu: Move right / Skip into next submenu

Description			
1	Operating Mode	2	Pressure Reading
3	Additional Info	4	Keypad
5	Charge of Battery	6	Pressure Unit

Operating Mode

In the measurement menu operating modes “Continuous” (continuous operation) or “Auto-Off” (automatic switch-off) can be selected by means of the “Arrow Up” key.

In continuous operation the device remains powered on without limit or until an editable maximum operation time has elapsed, depending of the device configuration. In “Auto-Off” mode the device will be switched off automatically after approx. 20 seconds in order to save battery power.

Key Lock

To prevent unintended inputs or changes you can activate a key lock. This is possible in the measurement menu, while pressure diagrams are plotted or during a leakage rate measurement. To activate key lock the “Arrow Up” key has to be pressed for more than 3 seconds. When the keys are locked a padlock symbol is shown in the upper line of the display.

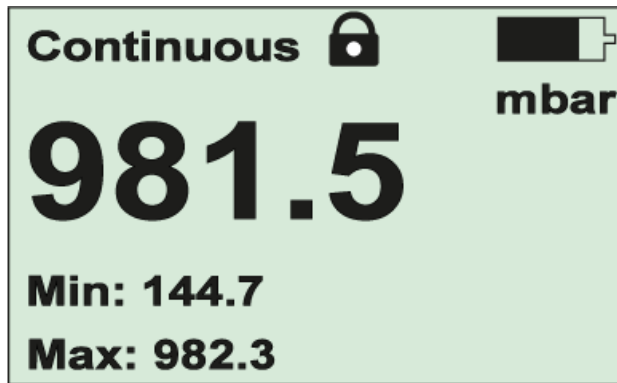

To disable key lock press the “Arrow Up” key twice within 5 seconds.

Additional Info

In the measurement menu the type of the additional information displayed can be changed by means of the “Arrow Down” key. You can select the current values for stored minimum and maximum pressure, relative or absolute pressure as well as date and time.

Reset minimum and maximum pressure

In the measurement menu you can reset the values for stored minimum and maximum pressure by pressing the “Arrow Down” key for more than 3 s.

4.3 Start and Stop Data Logging

Your VACTEST TRP 701/901 D can be operated as data logger. Multiple measurements in separate data files of type VACTEST Explorer (*.vgw) can be saved in the internal memory. Memory size will be sufficient for several million data points.

By means of the VACTEST Explorer PC software stored measurement data can be uploaded to a PC for plotting, analysis or further export to MS Excel (see 6 VACTEST Explorer Software [→ 31]).



NOTICE

While data logging is active the device will not be switched off automatically after 20 seconds or when a maximum operation time has elapsed! Instead a fixed timespan for data recording can optionally be defined (see 4.6.1 Logging Mode [→ 15]).

Start data logging

To start data logging select item "Start Logging" in the main menu:

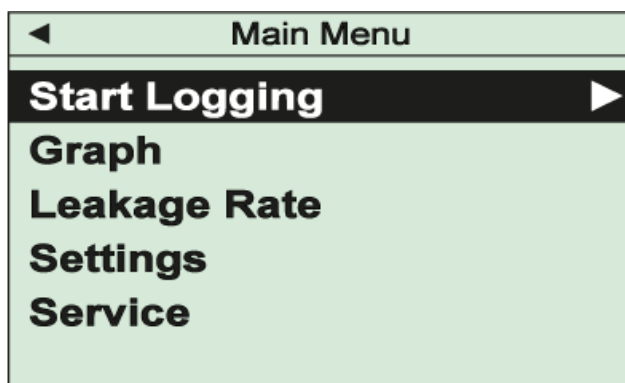

An information screen displays the automatically allocated filename as well as the currently set logging rate. After confirmation by the "OK"-Key data logging will start. In the measurement menu "Logging" is displayed as operating mode.

Stop data logging

To stop data logging select "Stop Logging" in the main menu, then choose "OK" and quit.

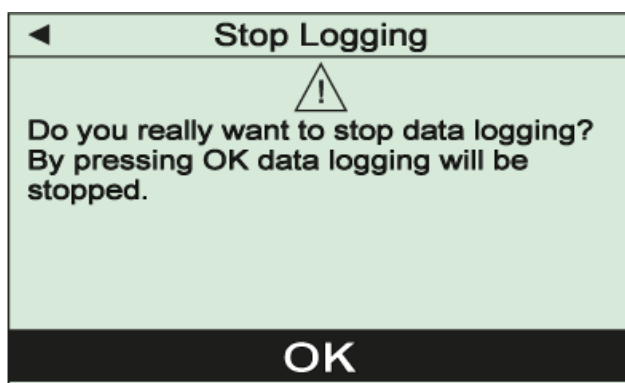

4.4 Graph

The VACTEST TRP 701/901 D can plot measurements as pressure-vs-time diagram. Diagram options can be adjusted as described in section 4.6.2 *Diagram-Options*. [→ 17]
To start plotting measurements in a diagram select item “Graph” from the main menu:

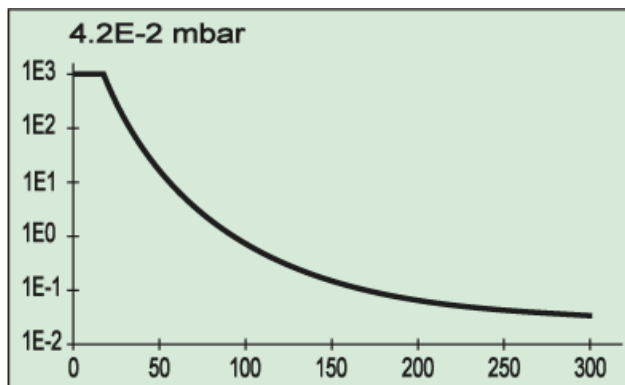
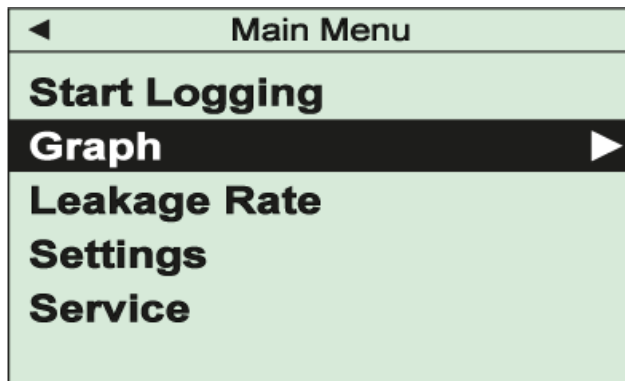

Depending on the diagram settings pressure readings will now be plotted over time. The current pressure reading is displayed numerically on top of the diagram. The diagram can be resetted by pressing and holding the “ARROW DOWN” key for 3 seconds. To stop data plotting and return to the main menu just press the “Arrow Left” key.

4.5 Calculation of Leakage Rates

By means of a rate-of-rise measurement the VACTEST TRP 701/901 D is able to calculate the leakage rate of a vacuum system.

To start a rate-of-rise measurement select "Leakage Rate" from the main menu:

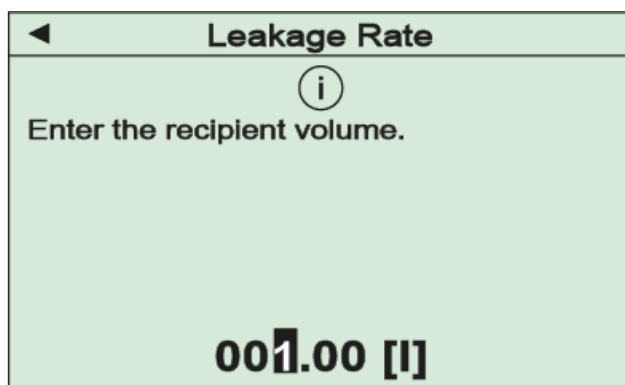
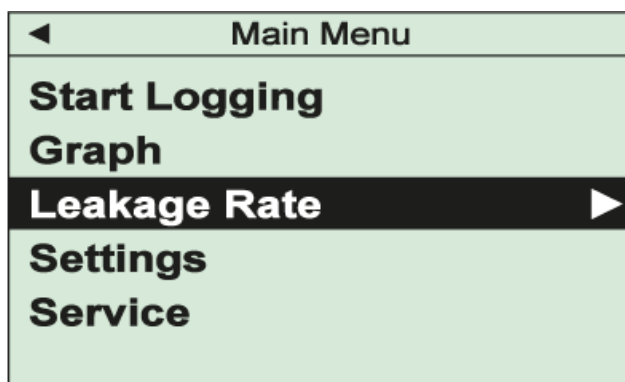

In the next step the internal volume of the vacuum vessel or system has to be entered. After confirmation of the adjusted value by means of the "OK" key the rate-of-rise measurement will be started continuously updating the calculated result for the leakage rate:

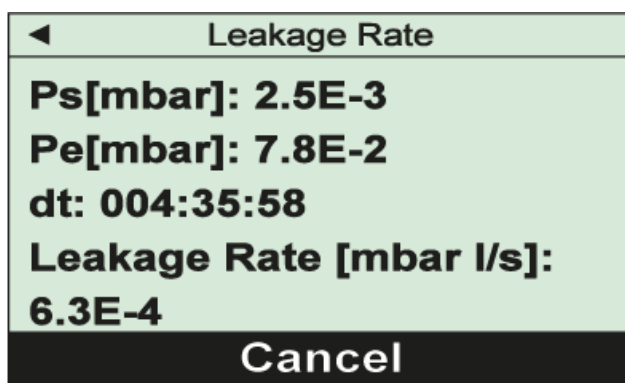

The display shows start pressure P_s , current end pressure P_e , elapsed time dt as well as the calculated leakage rate.

To end the rate-of-rise measurement and return to the main menu press the "OK" key.

4.6 Settings

In order to adjust settings select item "Settings" from the main menu.

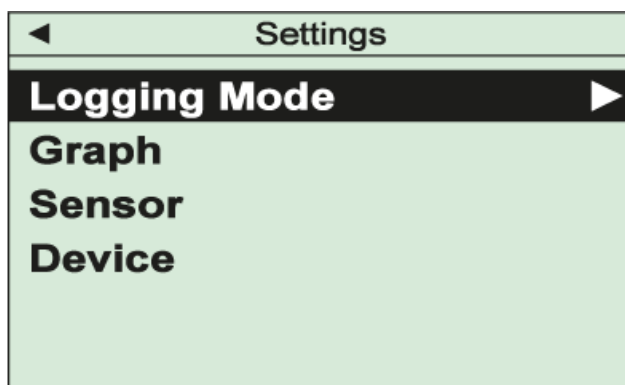
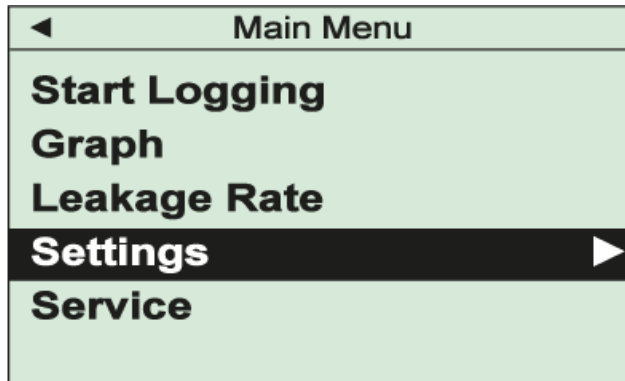

4.6.1 Logging Mode

Select item "Logging Mode" in the "Settings" menu to adjust parameters for data logger operation, i.e. logging interval and an automatic stop after a desired time limit.

Logging Interval

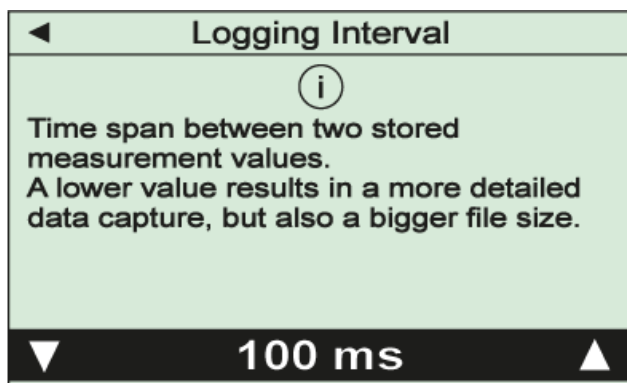
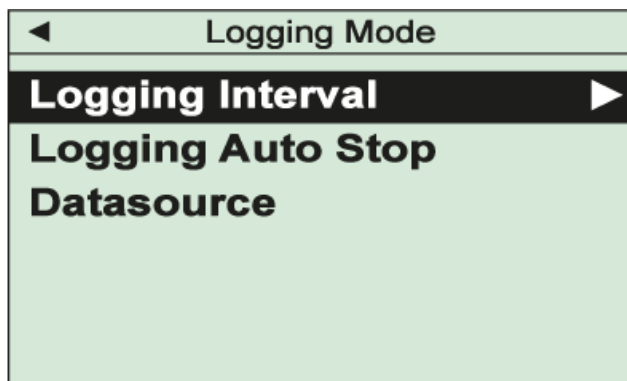

Measurement data will be stored with this adjustable time interval after the data logging is started. The edited value must finally be confirmed with the "OK"-key.

Logging Auto Stop

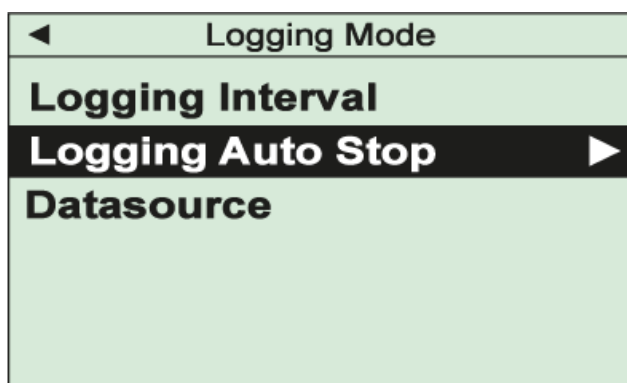

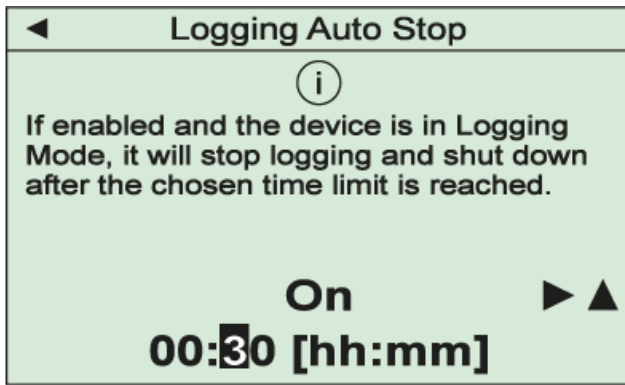

 **CAUTION**

Logging interval and required logging period should match to avoid unnecessarily high data volumes!

This function will terminate data logging automatically after an adjustable time limit.

In the first step the function has to be enabled or disabled. To enable select "On" and then "Arrow right" to switch to the adjustment of the time limit. The edited value must finally be confirmed with the "OK"-key.

In order to log data without time limit select "Off" and confirm. Data logging can then be stopped manually as described in 4.3 Start and Stop Data Logging [→ 11].

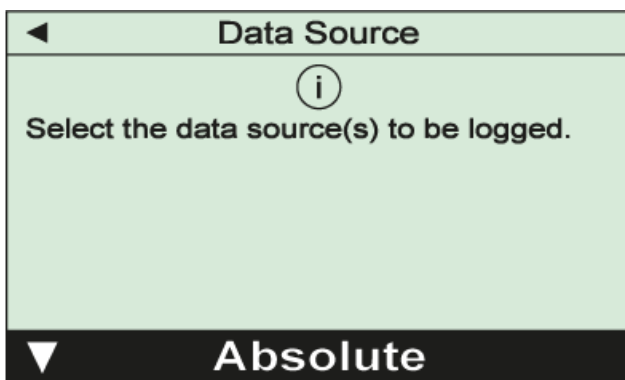
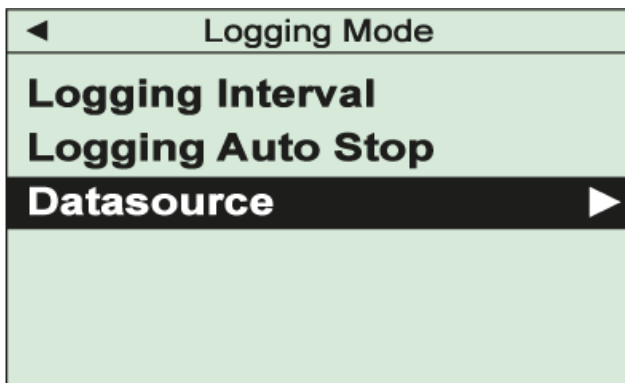

In this menu you can select the data sources for data logging, i.e. if absolute pressure, relative pressure or both should be recorded. The selection must finally be confirmed with the "OK"-key.

4.6.2 Diagram-Options

By selecting item "Graph" in the "Settings" menu you can adjust parameters for the graphic display of measurements as a pressure-over-time diagram, i.e. data source, time mode and axis options.

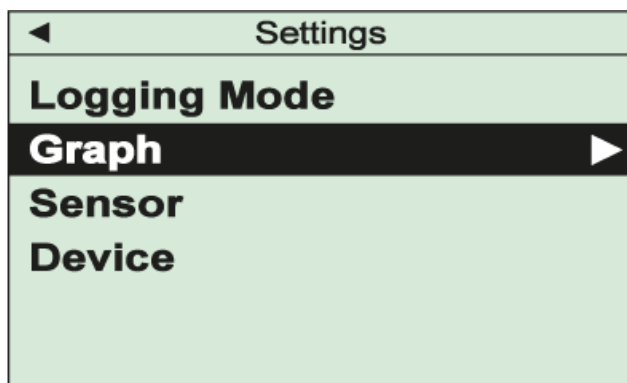

Graph Mode

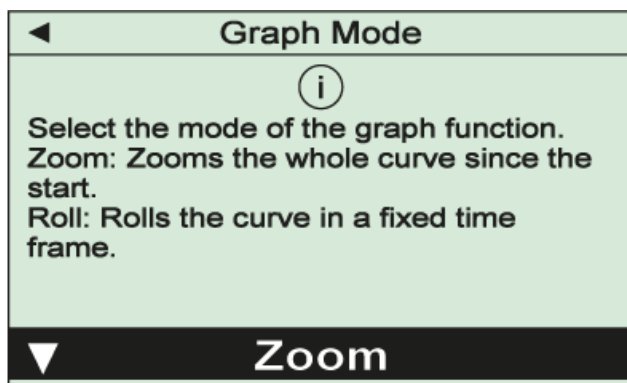
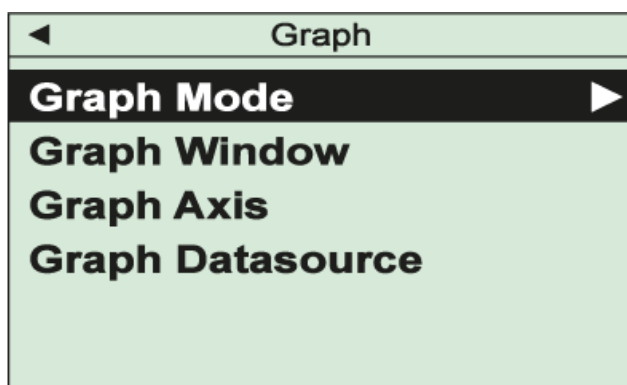

Under this menu item you can choose whether the pressure-over-time diagram will show all measurements beginning from the start of the plot ("Zoom") or whether measurements are plotted in a rolling mode within an adjustable time frame including the current reading ("Roll"). The setting must finally be confirmed with the "OK"-key.

Graph Window

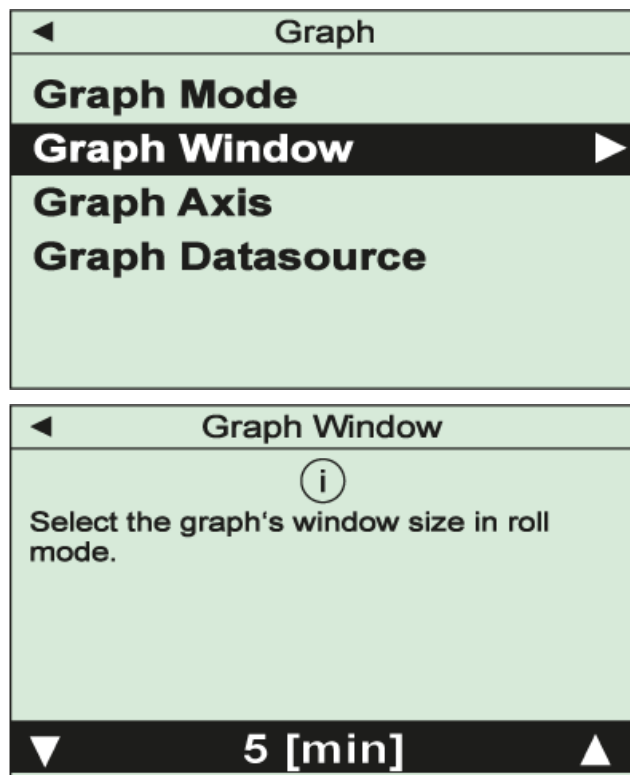

If a rolling mode has been selected as "Graph Mode" this menu item will allow to set the required time frame for the diagram. The setting must finally be confirmed with the "OK"-key.

Graph Axis

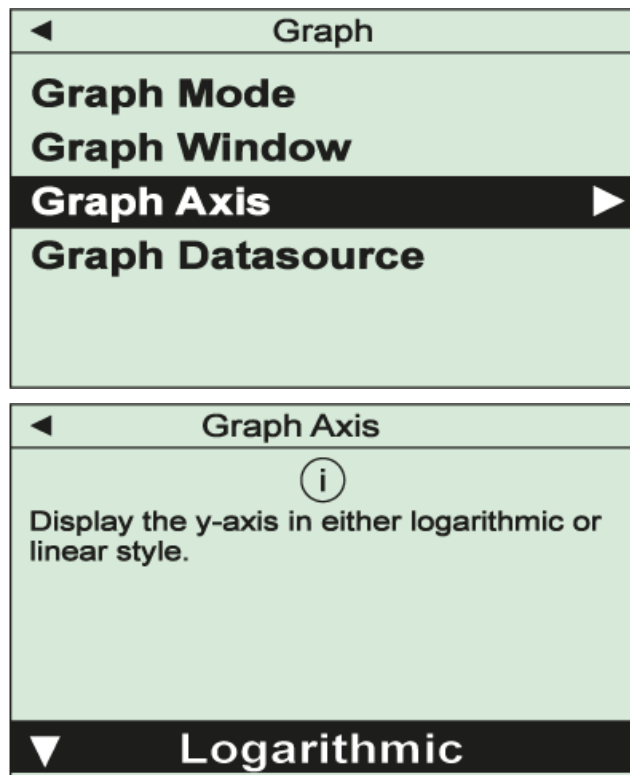

Use this menu item to select whether the y-axis of your plot shall have linear or logarithmic scaling. The setting must finally be confirmed with the "OK"-key.

Graph Datasource

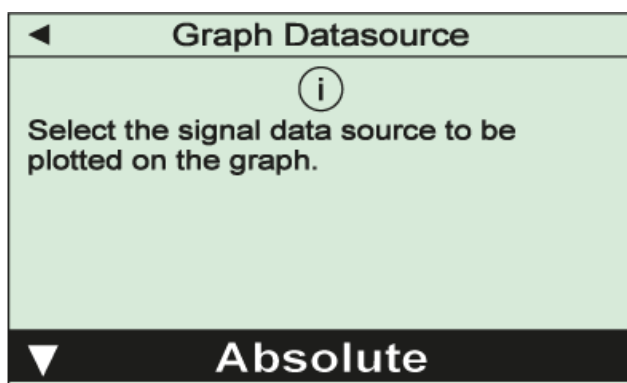
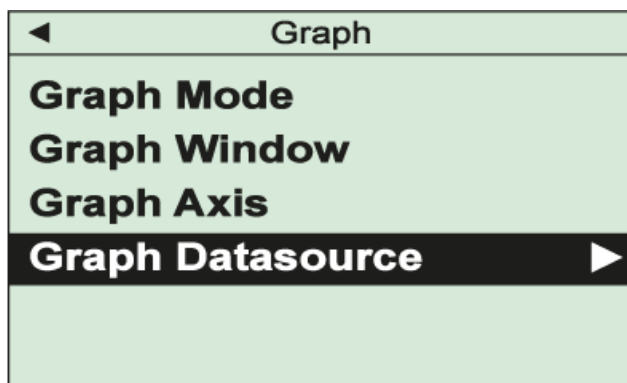

Use this menu item to select the data source for the plot, i.e. absolute or relative pressure. The setting must finally be confirmed with the "OK"-key.

4.6.3 Sensor

Choose menu item "Settings" / "Sensor" to re-adjust the sensors of your VACTEST TRP 701/901 D.

Adjust

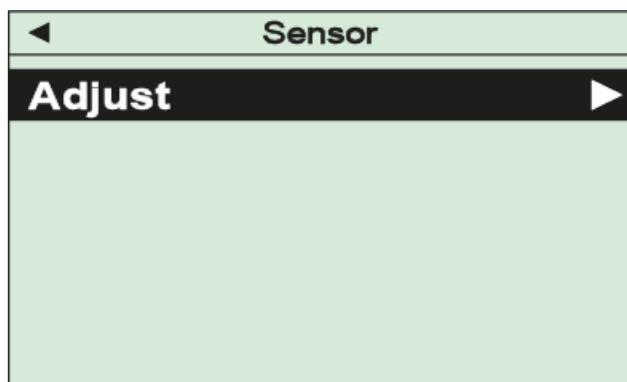

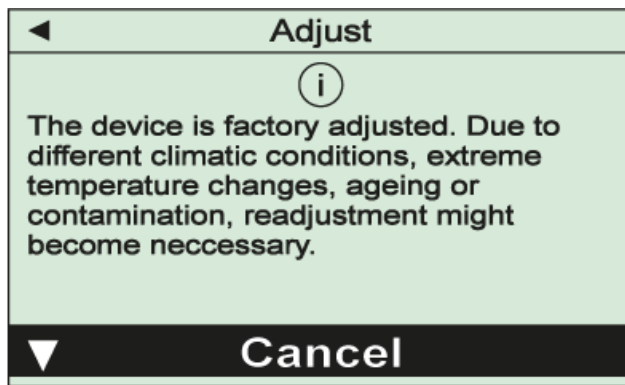

This function is used to re-adjust the sensors. Select between

- "Adjust Zero" : adjustment at zero pressure
- "Adjust Zero [p]" : adjustment at reference zero pressure
- "Adjust ATM" : adjustment at atmospheric pressure
- "Adjust Relative" : set relative pressure to zero.

After confirmation by selecting "Execute" the adjustment will be carried out and a corresponding acknowledgement is displayed.

For an adjustment at atmospheric pressure or at reference zero pressure a value for the actual pressure has to be entered. For this purpose a suitable reference gauge will be needed:

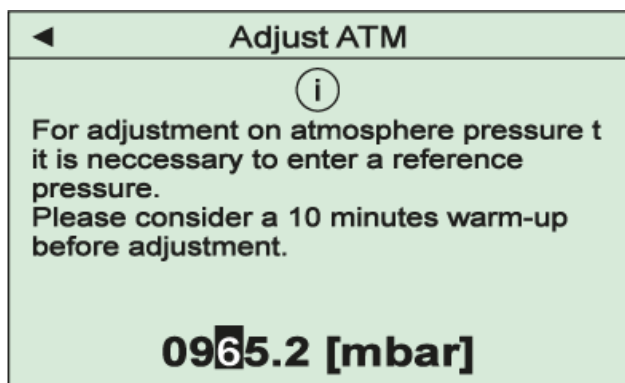
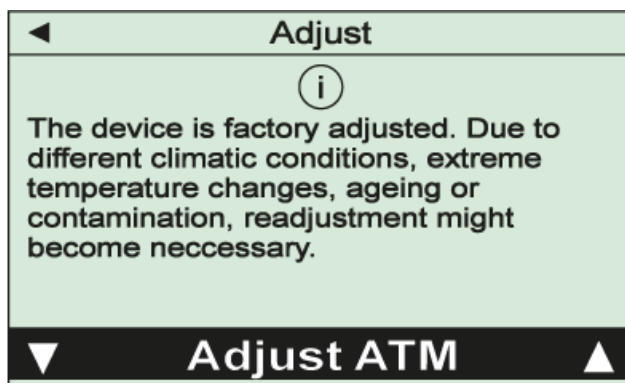

NOTE



To achieve optimal results of an adjustment we recommend to consider a warm-up period of at least 10 minutes at the required adjustment pressure.

For adjustment at zero pressure actual pressure must be at least one decade below the lower range limit of the VACTEST TRP 701/901 D .

4.6.4 Device Settings

Under menu "Settings" / "Device" you can change basic settings of your VACTEST TRP 701/901 D.

Alarm Buzzer

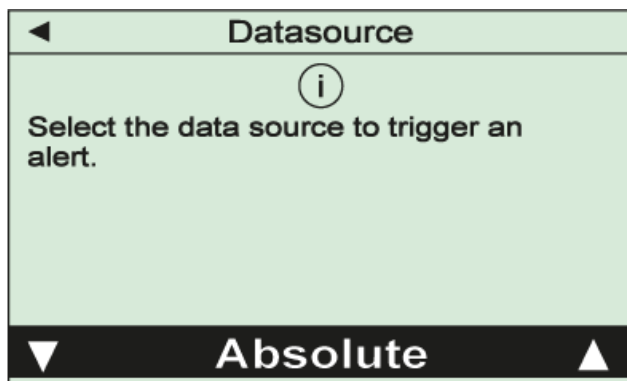
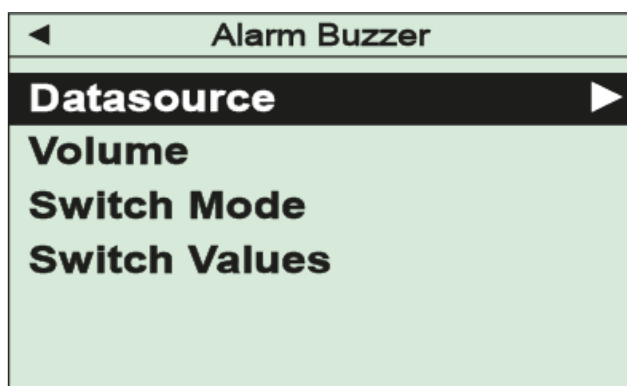
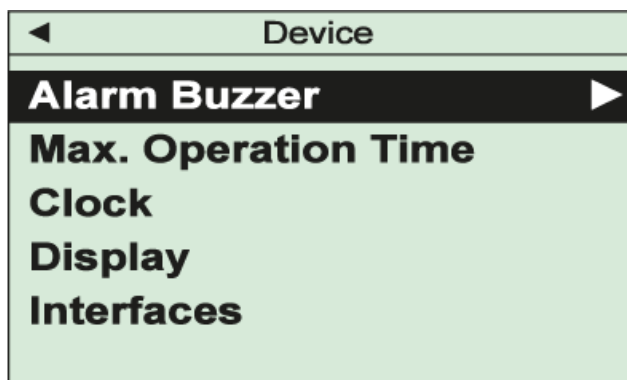

With this function an optic and acoustic alert function can be activated.

Under "Datasource" you can initially activate the alarm buzzer and select which measurement signal should trigger the alert.

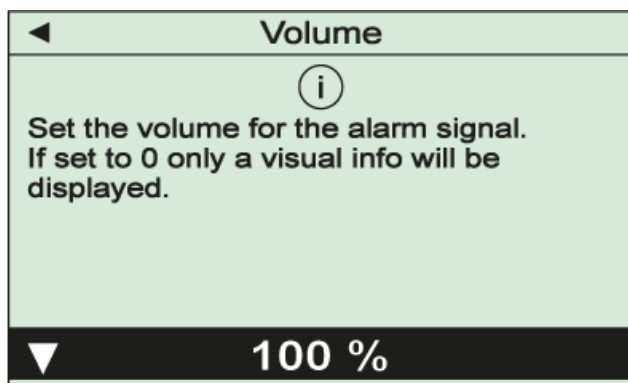
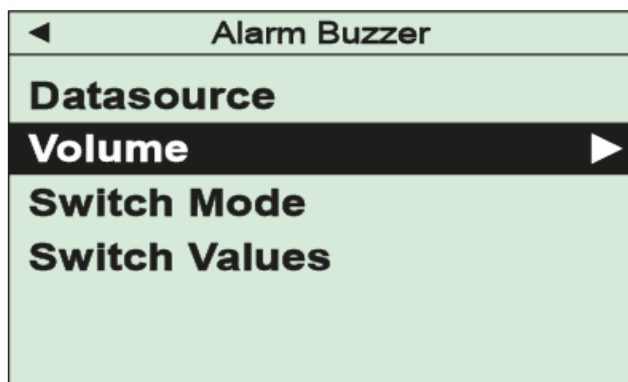

Under "Volume" the loudness of the alert signal can be adjusted.

Depending on the settings made under menu item "Switch Mode" the alert will be triggered, as soon as an adjustable threshold is under- or overshot or if a device error has occurred:

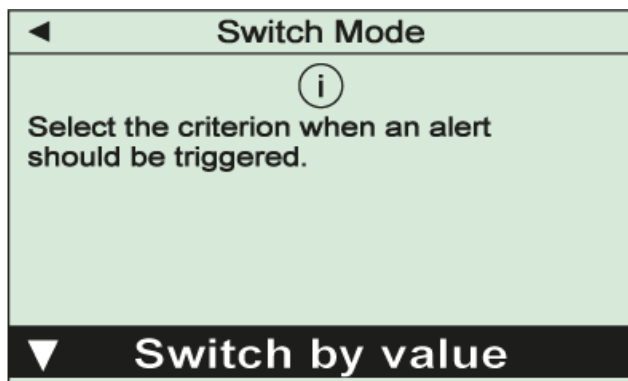
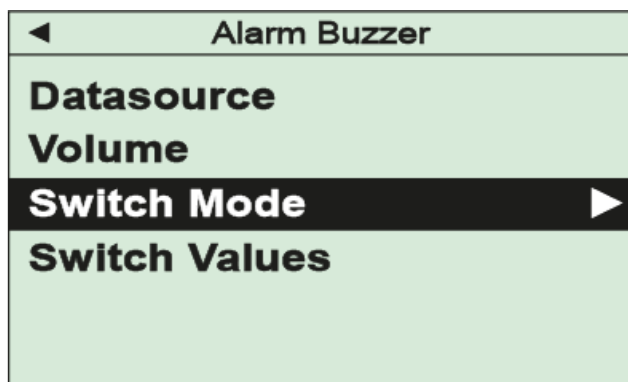

The thresholds to switch-on and switch-off the alert can be edited under menu "Switch Values".

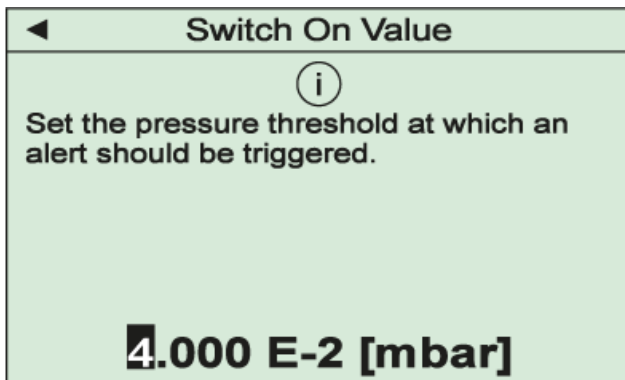
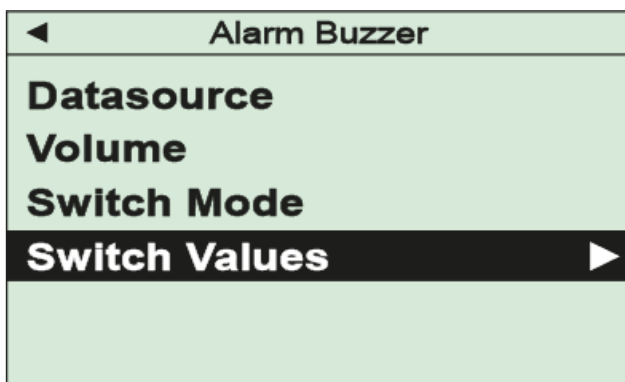

All settings must finally be confirmed with the "OK"-key.

Max. Operation Time

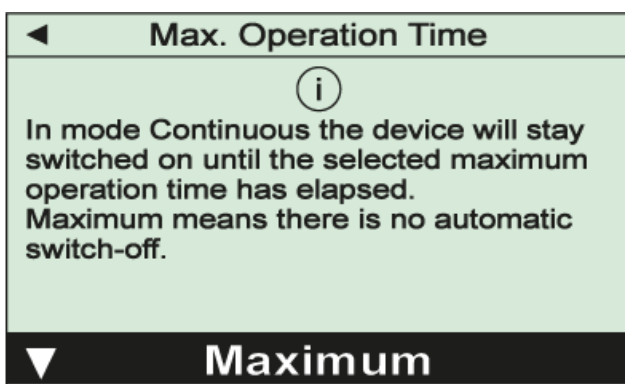
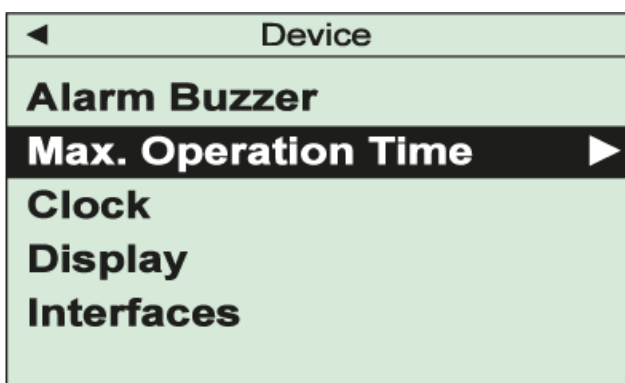

This function assures that the VACTEST TRP 701/901 D will be switched-off after an adjustable maximum operation time even in operation mode "Continuous". This will avoid unintended discharge of the battery. You can select "Maximum" (no switch-off) and pre-defined time periods between 30 min and 5 h.

The setting must finally be confirmed with the "OK"-key.

Clock

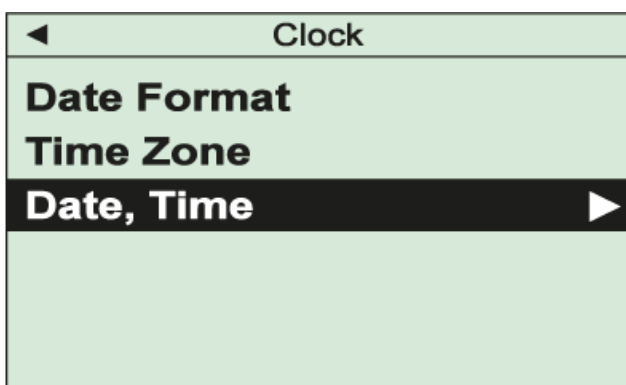
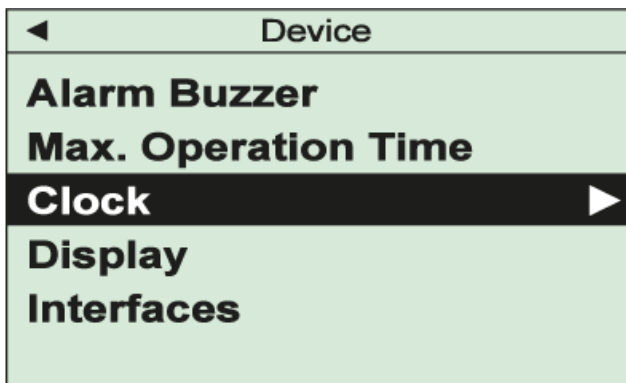

Use these menu items for setting date format, time zone and time for the integrated real-time clock of the device:

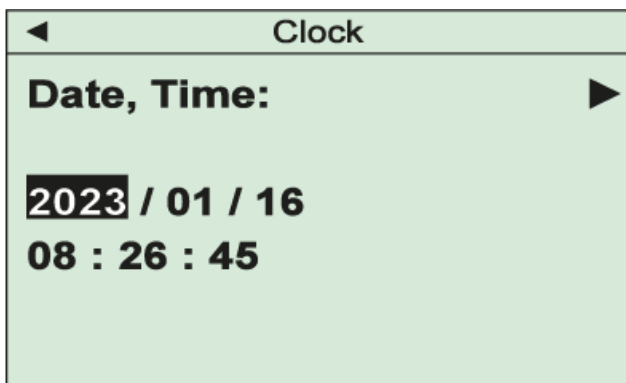

All settings must finally be confirmed with the "OK"-key.

Display

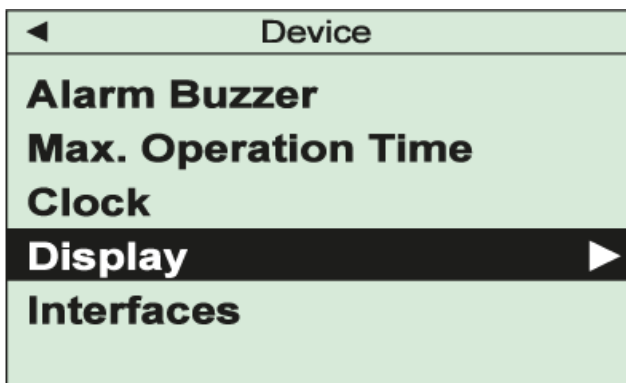

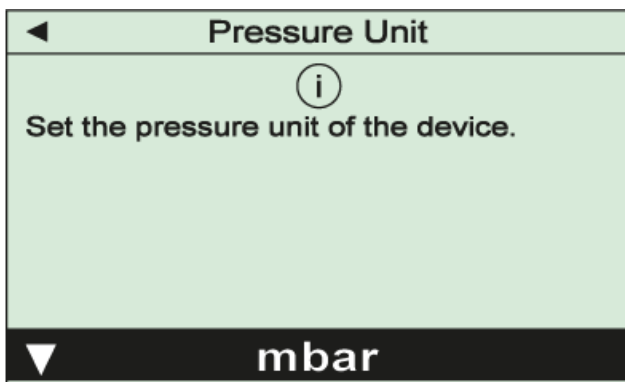
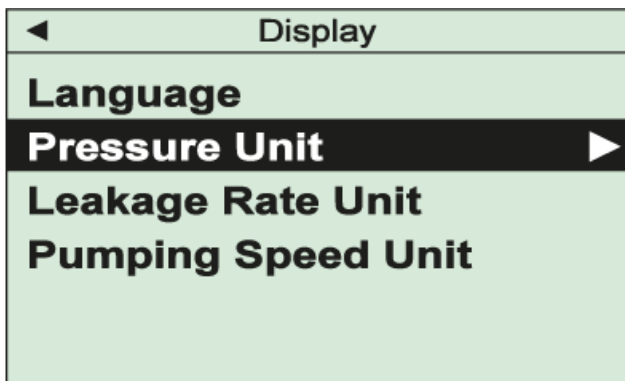
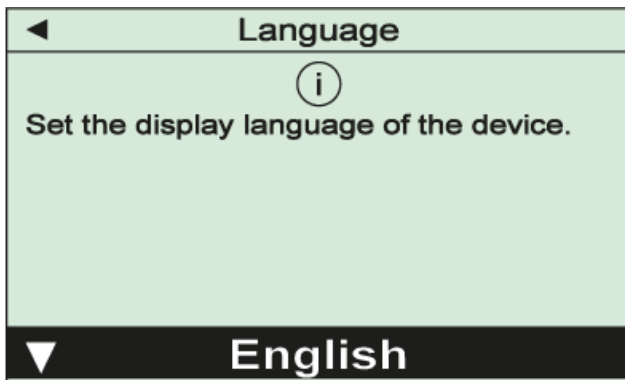
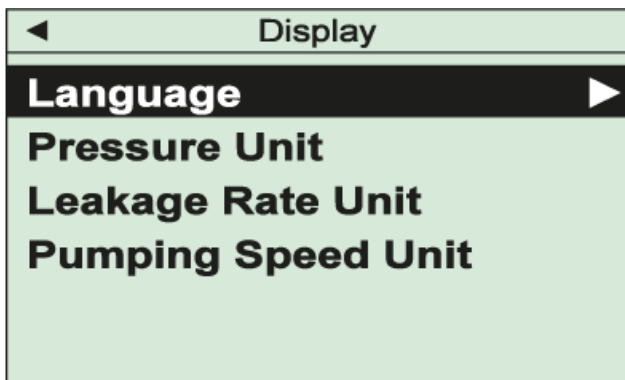

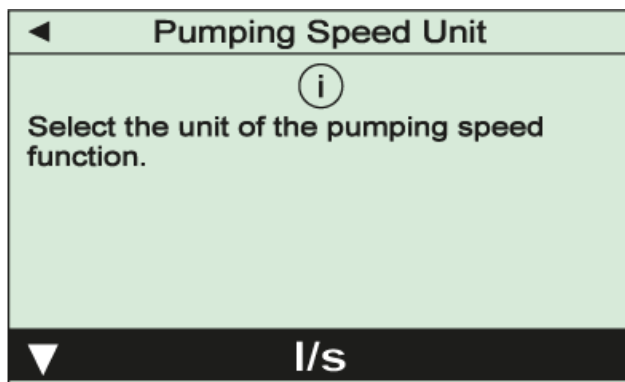
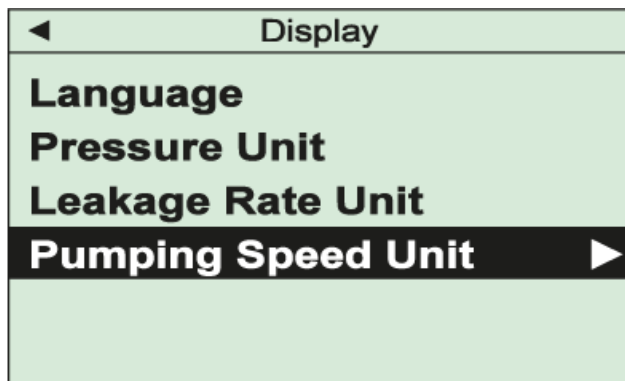
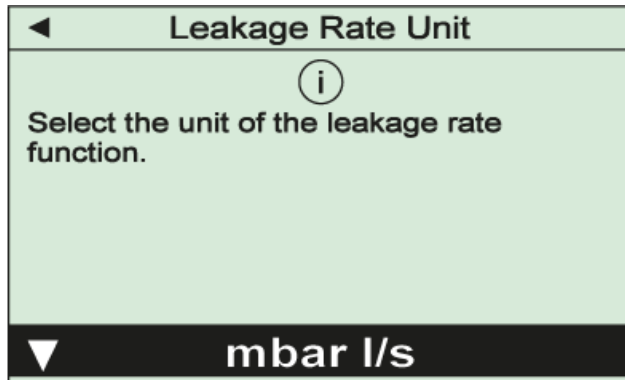
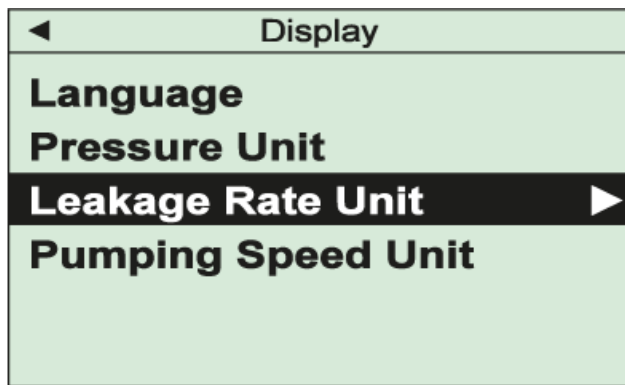

The menu is used to select menu language and display units. All settings must finally be confirmed with the "OK"-key.

Interfaces

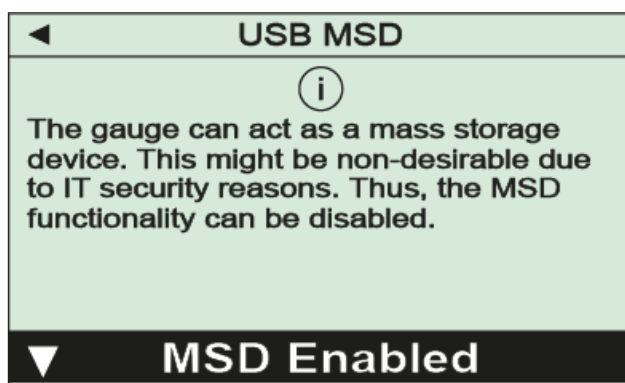
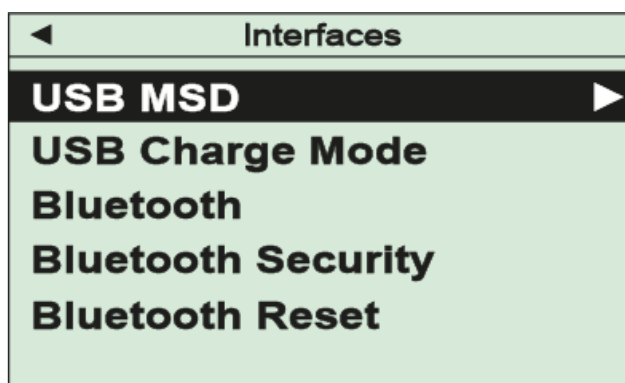
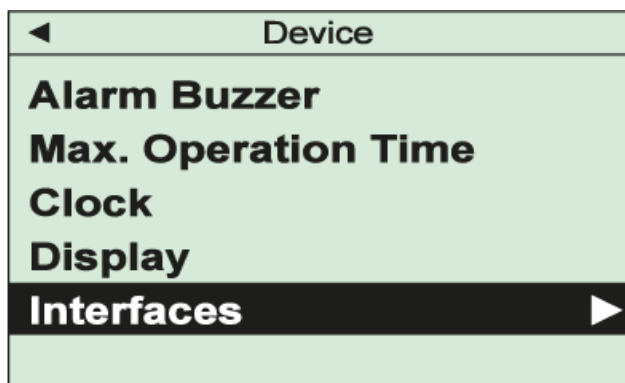

This menu is used to adjust settings of the USB interface and the Bluetooth interface of the VACTEST TRP 701/901 D.

Ex works the device is configured as mass storage device ("MSD Enabled"), so the stored measurement files will be displayed when the VACTEST TRP 701/901 D is connected to a PC. If required this function can be disabled selecting "MSD Disabled".

Under menu item "USB Charge Mode" a limit for the admissible charging current can be set. This value must be supported by the connected current supply in order to avoid damage of the USB port.

Menu item "Bluetooth" is used to enable the device's optional Bluetooth interface. With standard setting a pass key is generated to establish a secured connection. With menu item "Bluetooth Security" you can optionally choose to establish connections without pass key. "Bluetooth Reset" is used to delete established Bluetooth connections.

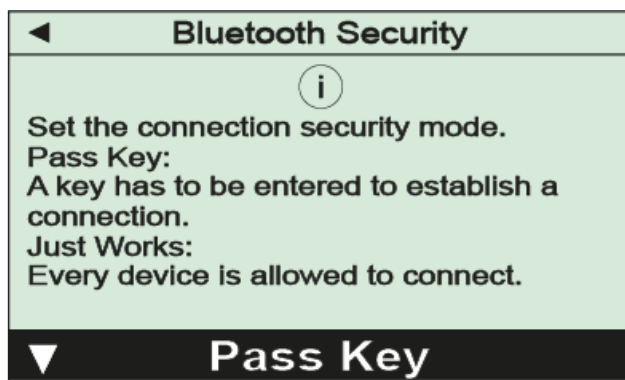
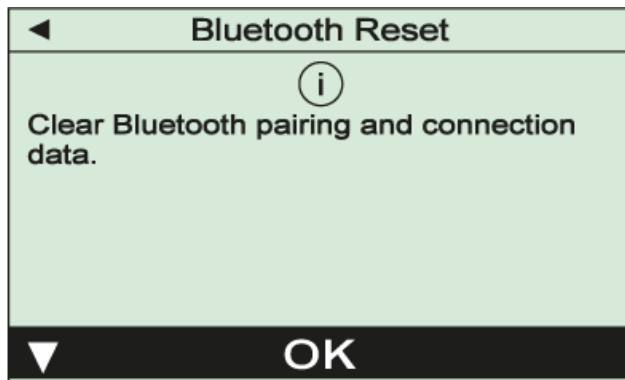
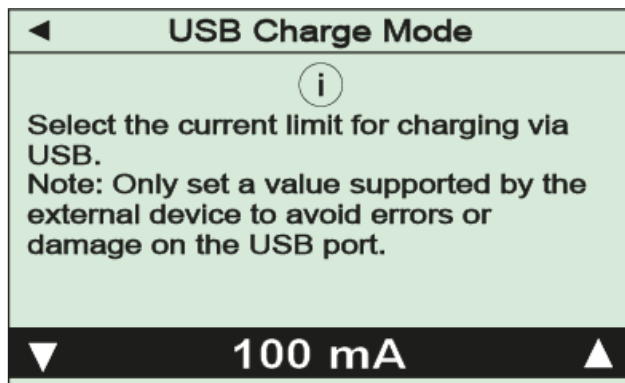

All settings must finally be confirmed with the "OK"-key.

5 Device Information

In menu "Service" you can display information regarding device and sensor. Further it is possible to format the memory of the data logger.

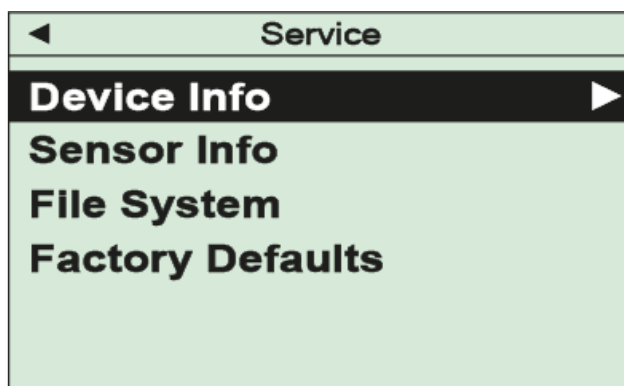
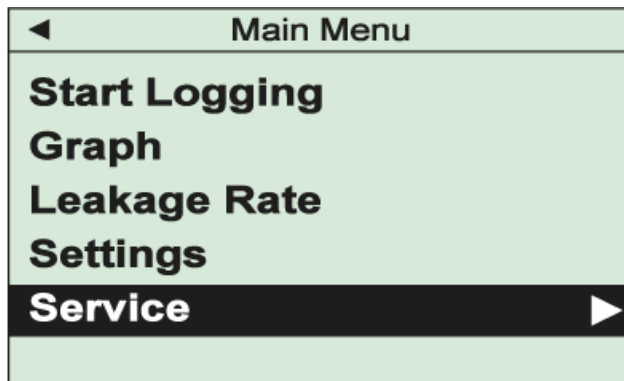

Device Info

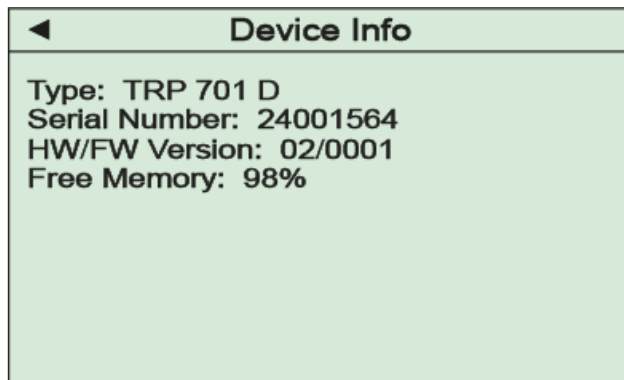

Sensor Info

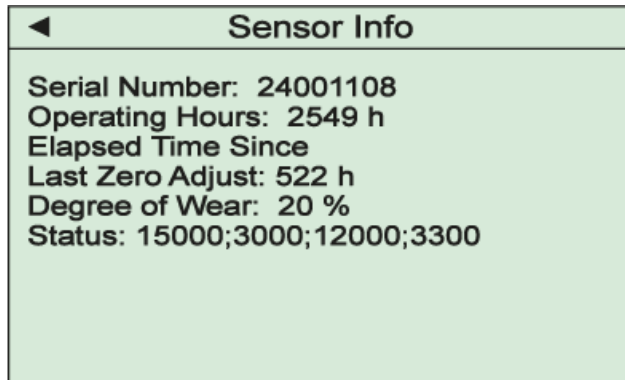

Under this menu item information regarding the sensor of your device is listed, for example parameters that will help to estimate the degree of wear and tear.

Displayed is a counter of operating hours as well as the number of operating hours which have elapsed since the last zero adjustment of the sensor.



NOTE



Any validation of the degree of wear must always be related to the specific application!

File System

This menu item can be used to format the file system of the data memory, e.g. in order to delete all recorded measurements.

Factory defaults

Under this menu item all device parameters can be reset to factory defaults.

6 VACTEST Explorer Software

VACTEST Explorer software has been especially developed for use with VACTEST gauges from **Busch Vacuum Solutions** and is compatible with operating system Windows.

VACTEST Explorer features plotting and saving of measurement data as well as comfortable configuration of all device parameters.

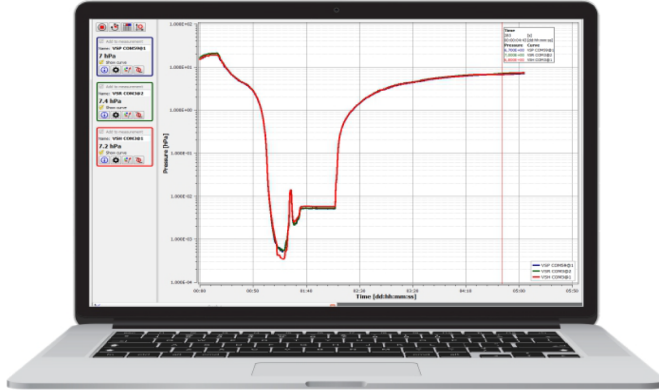

Download: www.buschvacuum.com

- Plot, analyze and save measurement curves
- Compare multiple plots
- Export measurement data for MS Excel
- Transfer of recorded measurements from the data logger to a PC
- Automatic calculation of leak rates from rate-of-rise measurements
- Easy configuration of all device parameters

Without a VACTEST Explorer Pro license, users face the following constraints:

- No saving, exporting, printing, or timing of measurements.
- A maximum measurement duration of 5 minutes.
- Limited to one live measurement tab/window.
- Inability to read datalogger devices.

Upgrading to a VACTEST Explorer Pro license removes these restrictions, offering a more versatile and efficient measurement experience.

7 Maintenance and Service



DANGER

Danger of possibly contaminated parts!

Contaminated parts can cause personal injuries.

- Inform yourself regarding possible contamination before you start working.
- Be sure to follow the relevant instructions and take care of necessary protective measures.



CAUTION

The unit is not prepared for customer repair!

Defective sensor heads can be exchanged on-site by calibrated replacement sensors.



NOTE



Malfunction of the unit which is caused by contamination or wear and tear is not covered by warranty.

The unit requires no maintenance. External dirt and soiling can be removed by a damp cloth.

When returning the gauge for service please fill out a declaration of contamination and include it in the shipment. This document is mandatory to protect our service staff.

7.1 Errors and Malfunctions

The device will show error messages as plain text on the display. Additionally, the following typical issues can appear:

Problem	Possible Cause	Correction
High measurement error	Wear and tear, contamination, extreme temperature	Replace sensor or send unit to repair
Display OR	Pressure over range	(Pressure is above range limit)
Display UR	Pressure under range	(Pressure is below range limit)

7.2 Important Notes for Disposal

According to WEEE directive 2012/19/EU and ElektroG3, the national law regarding distribution, withdrawal and environmentally acceptable disposal of electric and electronic equipment, this product must not be dumped in normal unsorted waste. For withdrawal and free disposal of used appliances please contact your Busch Vacuum Solutions service or return the product with a filled-in declaration of contamination. Alternatively, you can dispose used appliances at officially set-up collecting points.

If your instrument contains batteries or rechargeable batteries, these must be removed and properly disposed in compliance with applicable national directives. The end user is legally obligated to return used batteries, they must not be dumped in normal unsorted waste. Batteries or rechargeable batteries may contain harmful substances or heavy metals, symbols shown on the battery have the following meaning:

Pb - battery contains more than 0,004 mass percent of lead

Cd - battery contains more than 0,002 mass percent of cadmium

Hg - battery contains more than 0,0005 mass percent of mercury

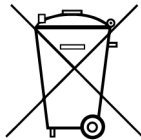

The symbol of a crossed dustbin denotes that marked products must not be dumped in normal unsorted waste but must be returned at officially set-up collecting points.

8 Technical Data

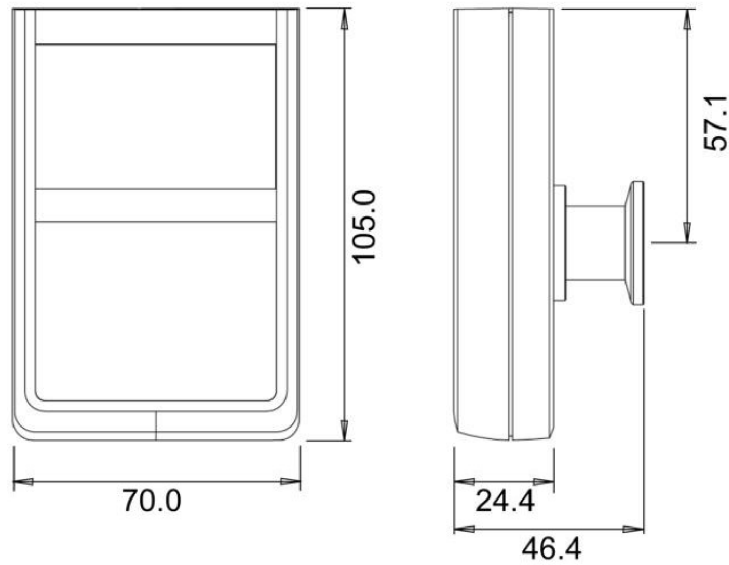

	VACTEST TRP 701 D	VACTEST TRP 901 D
Measurement principle	piezo-resistive	
Measurement range	absolute pressure: 2000 - 1 hPa (mbar) (1500 - 1 Torr) relative pressure: -1060 ... + 1200 hPa (mbar) (-795 ... + 900 Torr) (depending on ambient pressure)	
Max. overload	4 bar abs.	
Accuracy	absolute pressure: 0.25% f. scale end relative pressure: 0.30% f. span	
Repeatability	0.1% f. scale end	
Resolution	1 hPa (mbar)	
Materials in contact with vacuum	stainl. steel 1.4305, Al ₂ O ₃ -ceramic, Viton®	
Logging rates	20 ms ... 60 s	
Environment	Indoor, pollution degree max PD 2 Installing altitude max. 2000 m above normal sea level Rel. humidity max. 80% up to 30 °C, max. 50% at 40 °C, non-condensing	
Operating temperature	5 ... 50 °C	
Charge temperature	5 ... 40 °C	
Storage temperature	-20 ... +60 °C	
Voltage supply	5V DC via USB-C	
Operation time	Internal Li-battery: min. 1000 h	
Serial interface	USB 2.0, Bluetooth® LE	USB 2.0
Vacuum connection	Flange DN16 ISO-KF with G1/4" female thread	
Display	LCD graphic display, resolution 400 x 240	
Protection class	IP 40	
Weight	250 g	

9 EU Declaration of Conformity

The manufacturer

Busch Produktions GmbH
Schauinslandstr. 1
DE-79689 Maulburg

declares that the gauge: VACTEST TRP 701 D; VACTEST TRP 901 D

fulfill(s) all the relevant provisions from EU directives:

- 'Electromagnetic Compatibility' (EMC) 2014/30/EU
- 'RoHS' 2011/65/EU Restriction of the use of certain hazardous substances in electrical and electronic equipment (incl. all related applicable amendments)
- 'Radio Equipment Directive (RED)' 2014/53/EU
- 'Low Voltage Directive (LVD)' 2014/35/EU

and comply(-ies) with the following harmonized standards that have been used to fulfill those provisions:

Standard	Title of the Standard
EN 61326-1: 2013 Group 1 / Class B	Electrical equipment for measurement, control and laboratory use. EMC requirements. General requirements
EN IEC 63000:2018	Technical documentation for the assessment of electrical and electronic products with respect to the restriction of hazardous substances
EN 61010-1 : 2010	Safety requirements for electrical equipment for measurement, control, and laboratory use. General requirements
EN 300 328 V2.2.2	Wideband transmission systems; Data transmission equipment operating in the 2,4 GHz band; Harmonized Standard for access to radio spectrum
EN 301 489-1 V2.2.3	Electromagnetic Compatibility (EMC) standard for radio equipment and services; - Part 1: Common technical requirements; Harmonised Standard for ElectroMagnetic Compatibility
EN 301 489-17 V3.2.4	Electromagnetic Compatibility (EMC) standard for radio equipment and services; - Part 17: Specific conditions for Broadband Data Transmission Systems; Harmonised Standard for ElectroMagnetic Compatibility
EN 62311 : 2008	Assessment of electronic and electrical equipment related to human exposure restrictions for electromagnetic fields (0 Hz - 300 GHz)

Legal person authorized to compile the technical file and authorized representative in the EU (if the manufacturer is not located in the EU):

Busch Dienste GmbH
Schauinslandstr. 1
DE-79689 Maulburg

Maulburg, 02.01.2024



Dr. Martin Gutmann
General Manager
Busch Produktions GmbH

10 UK Declaration of Conformity

The manufacturer

Busch Produktions GmbH
Schauinslandstr. 1
DE-79689 Maulburg

declares that the gauge: VACTEST TRP 701 D; VACTEST TRP 901 D

fulfill(s) all the relevant provisions from UK legislations:

- Radio Equipment Regulations 2017
- Electrical Equipment (Safety) Regulations 2016

and comply(-ies) with the following designated standards that have been used to fulfill those provisions:

Standard	Title of the Standard
EN 61326-1: 2013 Group 1 / Class B	Electrical equipment for measurement, control and laboratory use. EMC requirements. General requirements
EN IEC 63000:2018	Technical documentation for the assessment of electrical and electronic products with respect to the restriction of hazardous substances
EN 61010-1 : 2010	Safety requirements for electrical equipment for measurement, control, and laboratory use. General requirements
EN 300 328 V2.2.2	Wideband transmission systems; Data transmission equipment operating in the 2,4 GHz band; Harmonized Standard for access to radio spectrum
EN 301 489-1 V2.2.3	Electromagnetic Compatibility (EMC) standard for radio equipment and services; - Part 1: Common technical requirements; Harmonised Standard for ElectroMagnetic Compatibility
EN 301 489-17 V3.2.4	Electromagnetic Compatibility (EMC) standard for radio equipment and services; - Part 17: Specific conditions for Broadband Data Transmission Systems; Harmonised Standard for ElectroMagnetic Compatibility
EN 62311 : 2008	Assessment of electronic and electrical equipment related to human exposure restrictions for electromagnetic fields (0 Hz - 300 GHz)

Legal person authorized to compile the technical file and importer in the UK
 (if the manufacturer is not located in the UK):

Busch (UK) Ltd
30 Hortonwood
Telford - UK

Maulburg, 02.01.2024



Dr. Martin Gutmann
General Manager
Busch Produktions GmbH

Notes

A large grid of small dots for taking notes, consisting of approximately 30 columns and 40 rows.

A large grid of small dots, intended for taking notes. The grid consists of approximately 30 columns and 40 rows of dots, spaced evenly across the page.



Busch

Vacuum Solutions

With a network of over 60 companies in more than 40 countries and agencies worldwide, Busch has a global presence. In every country, highly competent local personnel delivers custom-tailored support backed by a global network of expertise. Wherever you are. Whatever your business. We are there for you.

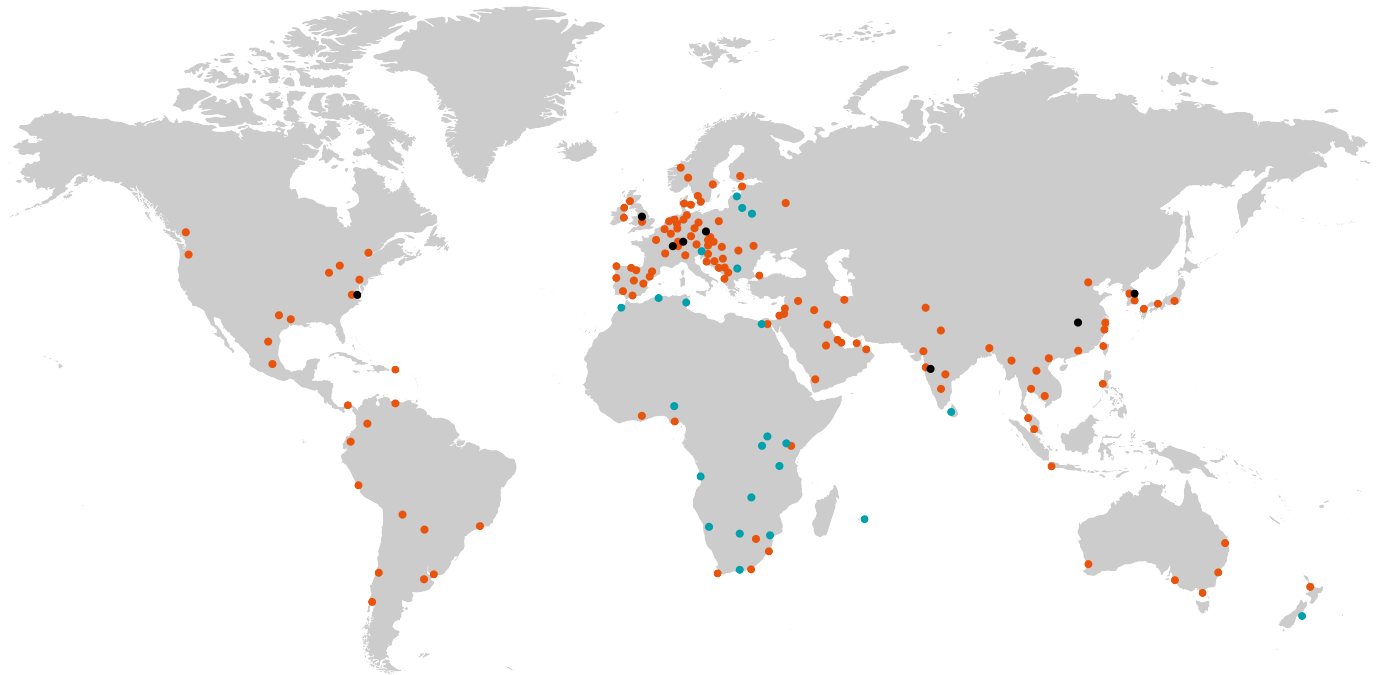

● Busch companies and Busch employees ● Local representatives and distributors ● Busch production site

www.buschvacuum.com